

Digital Cam Switch Unit

CamCon DC190

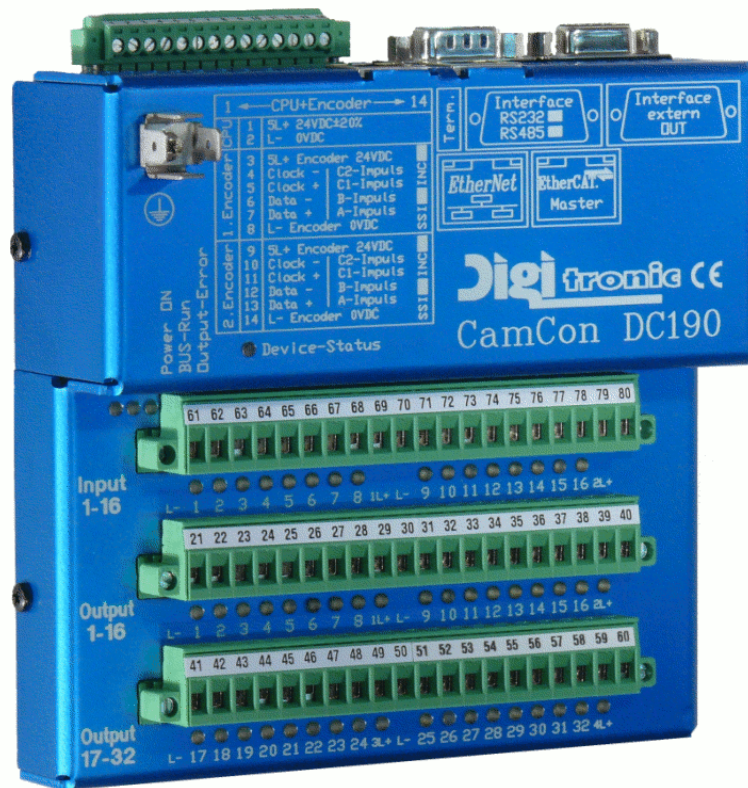

Digitronic Automationsanlagen GmbH

Auf der Langwies 1 · D - 65510 Hünstetten-Wallbach · Tel. +49 6126 9453-0 · Fax -42
Internet: <http://www.digitronic.com> · E-Mail: mail@digitronic.com

For your attention

This instruction manual relates to the CamCon DC190 from 11/2011. The company Digitronic Automationsanlagen GmbH reserves the right to make changes which present an improvement of the quality or functionality of the device without prior notice. The instruction manual was created with great care, although it may not be error-proof. We would be grateful for any communication relating to any errors you may have found.

Update

You can also obtain this instruction manual on the Internet at <http://www.digitronic.com> in the latest version as PDF file.

Qualified personnel

This device may only be started and operated by qualified staff. By qualified we mean personnel who are entitled to handle, to earth and to label devices, systems and power circuits in accordance with the technology safety standards.

Liability

(1) The supplier is liable for damages caused by himself or by the owner of the rights up to the sum of the sales price. He is not liable for loss of profits, forfeited savings, intermediate and successive damages.

(2) The above mentioned limits to liability do not apply to insurance of named characteristics and damages which were caused deliberately or through negligence.

Protection

The CamCon DC190 and this instruction manual are protected by copyright. All rights are reserved. Neither the CamCon DC190, nor this document may be copied as a whole or partially, photocopied, reproduced, translated or transferred to electronic media of any kind or into machine readable format without prior written permission by the company Digitronic Automationsanlagen GmbH.

Note: CamCon is a registered trademark of the company Firma Digitronic Automationsanlagen GmbH.

Note: The devices of the CamCon series comply with norms: DIN EN 61000-6-2, DIN EN 61000-4-2, DIN EN 61000-4-4, DIN EN 61000-4-5, DIN EN 61000-4-8 and DIN EN 55011 and RoHS 2 (2011/65/EU)..



(c) Copyright 1992 - 2017 / File: DC190E.DOC

Digitronic Automationsanlagen GmbH
Auf der Langwies 1
D-65510 Hünstetten - Wallbach
Tel. (+49)6126/9453-0 Fax. (+49)6126/9453-42
Internet: <http://www.digitronic.com>
E-Mail: mail@digitronic.com

Table of Contents

1. Introduction	6
2. Operating Principles	7
2.1. Speed Compensation	8
2.1.1. Measuring delay time for Speed Compensation	10
2.1.1.1. Measuring delay time through actual differences	10
2.1.1.2. Measuring delay time by means of different measuring points	10
2.1.2. Speed Compensation using off-centre pressure, e.g. brake functions	11
2.1.3. Not linear Speed Compensation (NLT)	12
2.1.4. Separate delay time for Speed Compensation of switch-ON and switch-OFF points	12
2.2. Time - Cam	12
3. Installation	13
3.1. Dimension	13
4. Electrical connections	14
4.1. Pin allocation of the CamCon	14
4.1.1. Pin allocation of the power supply	14
4.1.2. Pin allocation of 1. Measuring System - Input	14
4.1.2.1. Pin allocation of SSI Measuring System	14
4.1.2.2. Pin allocation of the incremental Measuring System (optional)	14
4.1.3. Pin allocation of the 2nd Measuring System input	14
4.1.3.1. Pin allocation of the 2nd SSI Measuring System	14
4.1.3.2. Pin allocation of the 2n incremental Measuring Systems (optional)	14
4.1.4. Pin allocation of Inputs 1 - 16	15
4.1.5. Pin allocation of Outputs 1 - 16	15
4.1.6. Pin allocation of outputs 17 - 32	16
4.2. PIN - Allocation of the Serial Interface	16
4.2.1. PIN - Allocation of the Serial Interface RS232	16
4.2.2. PIN - Allocation of the Serial Interface RS485 (Optional)	17
4.2.2.1. Terminal Resistors of the RS485 Interface	18
4.3. PIN - Allocation external Interface	18
4.4. Connecting the Ethernet Interface	19
4.5. Connecting the EtherCAT Interface	19
4.6. The measuring system	20
4.6.1. SSI Measuring system input	20
4.6.2. Parallel measuring system input	20
4.6.3. Incremental measuring system input	21
4.6.3.1. Incremental measuring system input with 5V RS422 level	21
4.6.3.2. Incremental measuring system input with 24V PNP level	21
4.6.3.3. Incremental Hiperface measuring system input with SINCOS level	22
4.6.4. Analog measuring system input	22
4.6.5. PLL measuring system input	23
4.6.6. Timer as a measuring system	23
4.6.7. RS232 as a measuring system	23
4.7. Outputs	24
4.8. Inputs	24
4.9. Precautionary measures for welding work	24
4.10. Status Display	25
4.10.1. The DC190 Status LED	26

5. Commissioning	26
5.1. Setting the IP-Address	26
6. Programming	28
6.1. Deleting the Cam Control.....	28
6.2. The Main Menu	29
6.3. Statusdisplay.....	29
6.4. Project data.....	29
6.4.1. CamCon device option.....	29
6.4.2. Offline - Simulation.....	30
6.5. Cam programming	30
6.5.1. Entering Cams	30
6.5.2. Entering the Speed Compensation	31
6.5.3. Selecting the Non - Linear - Speed Compensation.....	31
6.6. System settings.....	32
6.6.1. Measuring system	32
6.6.1.1. Select measuring system.....	32
6.6.1.2. Value Hysteresis	32
6.6.1.3. Speed max or measuring system control	32
6.6.1.4. Electronic Gear Transmission.....	33
6.6.1.4.1. The Electronic Rotation Direction Switch.....	33
6.6.1.5. Actual Value Display Format.....	33
6.6.1.6. Configuration of the special measuring system	34
6.6.1.6.1. Special measuring system - SSI	34
6.6.1.6.2. Special measuring system - Parallel.....	34
6.6.1.6.3. Special measuring system - Incremental.....	35
6.6.1.6.4. Special measuring system - Multi	36
6.6.1.6.5. Special Measuring System - PLL.....	37
6.6.1.6.6. Special measuring system - Timer	37
6.6.1.6.7. Special measuring system - AG615.....	38
6.6.1.6.8. Special measuring system - SIM	38
6.6.1.6.9. Special measuring system - HIPER.....	39
6.6.2. Measuring offset	40
6.6.3. Speed.....	41
6.6.4. Cable length.....	42
6.6.5. Special outputs.....	43
6.6.5.1. Special outputs digital	43
6.6.5.2. Special outputs analog.....	44
6.6.5.2.1. Analog cam configuring	45
6.6.5.2.2. Programming analog cams.....	46
6.6.6. System upgrading	47
6.6.7. Masterprogram.....	49
6.7. Configuration menu.....	50
6.7.1. Configure hardware.....	50
6.7.1.1. Advanced hardware configure	51
6.7.1.1.1. Advanced hardware configuration for CamCon and external interface	52
6.7.1.1.2. Back - Plan - Router Configuration	52
6.7.1.1.3. Ethercat hardware configuration	53
6.7.2. PLC configuration.....	54
6.7.3. Key allocation.....	54
6.7.4. Unit Configuration	55

7. PLC - Logic - Module programming	55
8. Error messages and removal of errors (FAQ)	56
8.1. Problem: Display shows "No contact to unit: XX"	56
8.2. Problem: "Pos - Err:1" respectively error number 1.....	56
8.3. Problem: "Pos - Err:2" respectively error number 2.....	56
8.4. Problem: "Pos - Err:3" respectively error number 3.....	57
8.5. Problem: "Pos - Err:5" respectively error number 5.....	57
8.6. Problem: An "Pos-Error:" occurs during operation.....	57
8.7. Problem: "RAM-Full" = RAM memory is full.....	57
8.8. Problem: The EEPROM memory is full.....	58
8.9. Problem: Outputs will not activate.....	58
8.10. Problem: "Out - Error" respectively error number 4.	58
8.11. Problem: Error in the EEPROM respectively error number 255.	58
8.12. Problem: "Error ???"	58
8.13. Problem: "Clear...." respectively error number 3.....	59
9. Technical Data	60
10. Index	61

1. Introduction

Electronic Cam Switch Units have been successfully used in industry for a long time. Experiences collected in close liaison with users over the years have been included in the development of the CamCon series. The result is a compact digital cam switch unit which is user friendly and reliable to a high degree. The following characteristics testify the excellence of the CamCon:

- * Tested and reliable hardware
- * Short-circuit-proof outputs
- * Graphic liquid crystal display with 128x64 pixels in the CamCon DC50,51.
- * Large and clearly visible 7-Segment display for program, position and speed on CamCon DC30,33 and 40.
- * Any number of cams per output can be programmed.
- * Up to 32000 Programs for product administration
- * Master, for example: machine cams
- * Optimising switch points when machine is in operation
- * Compensation of mechanical delay time of switch components for switch-ON and switch-OFF points can be set in steps of 100µs separately (DTC = delay time or Speed Compensation).
- * Not linear Speed Compensation (NLT).
- * Position - Triggert - Time - Cams
- * Power supply 24V DC +/- 20%
- * Mounting of suspension rails to EN 50022 on CamCon DC16 and 90
- * Switchboard panel standard casing 144 x 144 x 63mm to DIN 43700 on CamCon DC33,40 and 51
- * S5 Components group for S5 115U, 135U and 155U on CamCon DC115
- * S7 Components group for S7 300 on CamCon DC300
- * AB Components group for ControlLogix[®] 1756 on CamCon 1756-DICAM
- * S5 Switch-ON via PG interface with L1 - Bus on CamCon DC16,40,50,51 and 90
- * PLC Logic Module (optional)
- * Shift register (optional)
- * OP - Functions
- * Analog outputs (optional)

Cam switch units are used wherever switching operations are periodically repeated. Digital cam switch units are an optimum replacement of mechanical units and offer in addition many other advantages, such as:

- * Simplification of mounting and adjustment operations
- * Repeatable adjustment facility
- * Standardised for almost all areas of application
- * Reliability
- * High switch speed
- * Speed Compensation
- * Product administration for quick format change

2. Operating Principles

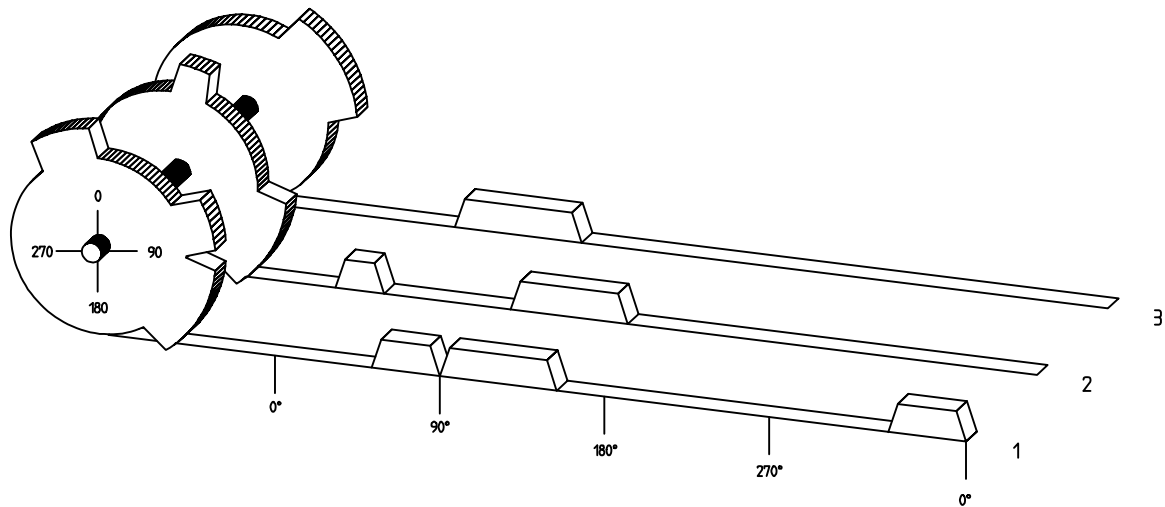

Diagram: Principles of a Cam Switch Unit

A principle for better comprehension of the function of a Cam Switch Unit is here presented. It has 3 outputs with the following cams:

Output 1:	Cam 1:	Switch-ON position	60°	Switch-OFF position	85°
	Cam 2:	Switch-ON position	95°	Switch-OFF position	145°
	Cam 3:	Switch-ON position	325°	Switch-OFF position	355°
Output 2:	Cam 1:	Switch-ON position	5°	Switch-OFF position	20°
	Cam 2:	Switch-ON position	95°	Switch-OFF position	145°
Output 3:	Cam 1:	Switch-ON position	30°	Switch-OFF position	85°

The positions of the output signals, here presented as three tracks, occur when the three cam disks turn anti-clockwise past a sensor, which scans the cams on the 0°-axis.

In a mechanical cam switch unit, the switch interval, i.e. the range between switch-ON and switch-OFF position are determined by the length of the cam. The length and the position of the cam can only be varied marginally and this is mechanically highly demanding and time consuming. With CamCon such adjustments can be realised in a fraction of time; in addition, there can be any number of tracks. A measuring system which is fitted to the device reports the position to the CamCon. The CamCon compares it with the programmed switch-ON and Switch-OFF positions of all outputs. If the position lies in the range of a programmed switch-ON / switch-OFF position (cam), then the respective outputs are active.

2.1. Speed Compensation

Each mechanical switch component (e.g. shield, magnetic valve) has a delay time, i.e. the time between the start signal and the actual switching of the contacts. In processes where positioning is executed on a moving system, this can cause problems. If such a process is driven with different speeds, different positions are caused. To avoid this happening, new timings for the switch signals of each speed would have to be calculated.

In order to illustrate the complicated issues surrounding delay time or speed compensation, this will be shown on the example of a packaging machine. In the process shown in the diagram, a glue point has to be placed in an exactly defined spot on a moving paper track.

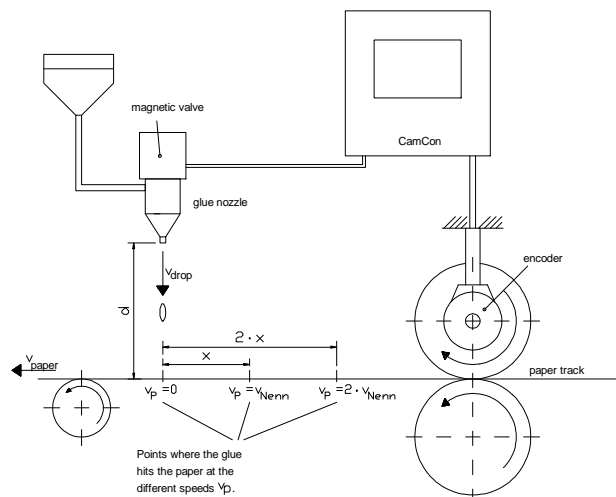

The system has the following parameters:

- v_p - Speed of the paper track
- v_T - Falling speed of the drop of glue
- d - Distance between the glue nozzle and the paper track
- T_{MV} - Delay time of the magnetic valve

Without speed compensation the following would happen:

As soon as the measuring system has reached a certain position, the CamCon sends a signal to the magnetic valve. The glue nozzle opens for a short time during which a drop of glue ejects. Between the start of the impulse and the exit of the drop time passes, which is mainly caused by the delay time of the magnetic valve T_{MV} . A further delay is caused by the time which the droplet needs to pass the distance between the glue nozzle and the surface of the paper.

This flight time is calculated as follows:

$$t_{\text{Flight}} = \frac{d}{v_T}$$

In total there the delay time is $t_{\text{Flight}} + T_{MV}$. During this time the paper track moves on by a specific distance x .

It would now be possible to move the position, where the magnetic valve is switched on, forward by a specific amount, so that the glue droplet hits the same spot again as during standstill. In this way a speed compensation is created which works only at a specific speed of the paper. As soon as the speed of the device and consequently that of the paper track is, for example, doubled, the hit point of the glue droplet is shifted by the distance x , so that, without any speed compensation, it would move backward by double the distance ($2 \cdot x$) in total.

The automatic speed compensation of the CamCon makes it now possible to drive processes with variable speed; CamCon registers the speed of the device continuously and adjusts the cams which determine the switch time points "On Line" depending on the speed. This has the effect that the outputs for the switch components are switched ON or OFF earlier. The direction of the movement is of no significance in this instance.

A small example in figures was designed to elucidate:

Supposing the drive cylinder with the measuring system has a circumference of 360mm, so that one millimeter of the circumference corresponds to exactly one angle degree of the measuring system.

The device has the following parameters:

$$\begin{aligned}v_{\text{droplet}} &= 20\text{m/s} \\d &= 20\text{cm} \\T_{\text{MV}} &= 20\text{ms}\end{aligned}$$

This results in the following flight time of the droplet:

$$t_{\text{Flight}} = \frac{d}{v_T} = \frac{0,2\text{m}}{20\text{m/s}} = 10\text{ms}$$

The total delay time is then $T_{\text{dead, altogether}} = T_{\text{MV}} + t_{\text{Flight}} = 20\text{ms} + 10\text{ms} = 30\text{ms}$

During this time the paper track moves on by the distance $x = v_{\text{paper}} \cdot T_{\text{total delay}} = 1\text{m/s} \cdot 30\text{ms} = 30\text{mm}$. In order to compensate the delay time, the switch point for the magnetic valve must be moved forward by 30° .

If the speed of the device and consequently that of the paper is doubled v_{paper} , then the distance x is also doubled by the speed of the paper track. In this case the switch point must be moved by 60° .

Note: Please take into account in these explanations that delay time is of a fixed size, which is determined by the mechanical constants of the set and switch components and by the dimensions of the construction and therefore does not change!

If the total delay time of 30ms was programmed into the respective output of CamCon, then the glue droplet would always hit the right spot, regardless of the speed.

2.1.1. Measuring delay time for Speed Compensation

Several ways of measuring delay time of a relay or valve are available.

2.1.1.1. Measuring delay time through actual differences

First the switch-ON point of a valve or relay is programmed. We assume that the programmed switch point lies at 200 degrees in this case. If the machine is driven with a speed of for example 40 rpm, a shift occurs due to delay time. This shift is then measured and, in this example, will amount to 40 degrees.

Warning: For the calculation of the shift the programmed delay time in the cam switch unit must be set to zero!

The delay time of the switch component is now calculated as follows:

$$\text{Delay time (in sec.)} = \frac{\Delta \text{ way (in } ^\circ \text{)} * 60 \text{ (sec./min.)}}{\text{speed (in rpm)} * 360 \text{ (}^\circ\text{/turn)}}$$

$$\text{Delay time (in sec.)} = \frac{40 * 60}{40 * 360} = 0.1667 \text{ sec.}$$

The resultant delay time is then entered into the cam switch unit.

See Chapter "6.5.2. Entering the Speed Compensation" an page 31.

2.1.1.2. Measuring delay time by means of different measuring points

First the switch point is calculated at a speed of, for example, 50 rpm. We assume that the programmed switch point lies at 200° in this case. The second measurement is taken at a speed of 80 rpm. The necessary switch point must be set to 160°, if the exact switch point is to be also achieved at 80 rpm.

Warning: For the calculation of the two switch points the programmed delay time in the cam switch unit must be set to zero!

The delay time of the switch component is then calculated with the following formula:

$$\text{Delay time (in sec.)} = \frac{\Delta \text{ way (in } ^\circ \text{)} * 60 \text{ (sec./min.)}}{\Delta \text{ speed (in rpm)} * 360 \text{ (}^\circ\text{/turn)}}$$

$$\text{Delay time (in sec.)} = \frac{40 * 60}{30 * 360} = 0.222 \text{ sec.}$$

The resultant delay time is then entered into the cam switch unit.

See Chapter "6.5.2. Entering the Speed Compensation" an page 31.

Since the entered delay time shifts the switch point, the previously programmed cam must be changed. For the calculation of the exact switch-ON position, the difference to the speed 0 rpm (here using 50 rpm) must be added to the first measured switch-ON point (here 200°). The difference is calculated with the following formula:

$$\Delta \text{ way (in degrees)} = \frac{\text{dead time (in sec.)} * \Delta \text{ time (in min}^{-1}\text{)} * 360 \text{ (degrees/rotations)}}{60 \text{ (sec./min.)}}$$

$$\Delta \text{ way (in degrees)} = \frac{0.222 * 50 * 360}{60} = 66.6 \text{ degrees}$$

The switch-ON point of the cam is now shifted from 200° by approx. 67° to 267°.

2.1.2. Speed Compensation using off-centre pressure, e.g. brake functions

The Speed Compensation of the CamCon Cam switch unit works using a linear function. If, for example, the speed doubles, then the shift of the compensated cam changes and also moves forward by twice the amount. If the ram on an eccentric press should be brought to a standstill at the exact upper stop point, the brake action of the press under different speeds results in a quadratic function. The Speed Compensation can therefore only find an approximation of the exact switch point for the stopping of the press by adjusting the line of the cam lines to the brake curves in the working range of the press.

Note: See also the next chapter "2.1.3. Not linear Speed Compensation (NLT)".

In the graphic on the right the curved line represents the brake point of the ram in relation to the speed.

For the calculation of the parameters to be programmed please proceed as follows:

- Define the working range (e.g. 20-50 rpm) and determine two measuring points which have to be specified in the working process (e.g. 30 and 40 rpm).
- Now let the machine run at 30 rpm and program or optimise a cam **without** Speed Compensation so that, at switch-OFF, the ram comes to a halt in top stop. Note the switch-ON point of the cam (e.g. 340°).
- Now let the machining work with 40 rpm and program or optimise one cam **without** Speed Compensation so that, at switch-OFF, the ram comes to a halt in top stop. Once again, note the switch-On point of the cam. (e.g. 332°).
- Now calculate the delay time, taking into account the distance and speed difference, using this formula:

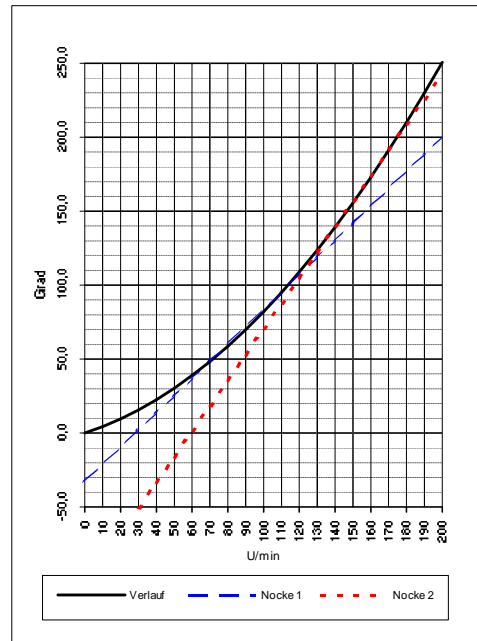

$$\text{Delay time (in sec.)} = \frac{\Delta \text{ way (in } ^\circ) * 60 \text{ (sec./min.)}}{\Delta \text{ Speed (in rpm.)} * 360 \text{ (}^\circ\text{/turn)}} = \frac{340-332 * 60}{40-30 * 360} = 0.133 \text{ sec.}$$

- The calculated delay time is now entered into the cam switch unit.
- Since the switch-OFF point has shifted through the entered Speed Compensation, the previously programmed cam must be changed first. For the calculation of the exact switch-ON position, the difference to the speed 0 rpm (here 30 rpm) must be added to the first measured switch-ON point (first measuring point here 340°) The difference is calculated with the following formula:

$$\Delta \text{ way (in } ^\circ) = \frac{\text{delay time (in sec.)} * \Delta \text{ Speed (in rpm.)} * 360 \text{ (}^\circ\text{/turn)}}{60 \text{ (sec./min.)}} = \frac{0.133 * 30 * 360}{60} = 23.94^\circ$$

- The switch-ON point of the cam has now shifted from 340° by approx. 24° to 364°.

As a result a cam with a switch-ON point of 4° and a speed compensation of 0.133 sec has been calculated. This is entered in the cam switch unit as switch-OFF cam of the press.

Note: If the degree of accuracy is no longer sufficient when switch-OFF is done with one cam, two or several outputs can be switched in parallel and the cam of those is then adjusted to the required working range. For the calculation of two switch-OFF cams divide the working range in 5 parts with 4 measuring points and then calculate the delay time value and the cam value with the same formula as described above. For the calculation of the first cam, use the measuring points 1 + 2 and for the calculation of the second cam use the measuring point 3 + 4.

Through this association of the linear cam functions to the brake functions it is now possible to switch OFF the cam via the entire working range of the press in the top stop.

2.1.3. Not linear Speed Compensation (NLT)

The method for the compensation of a not linear Speed Compensation, descriptive in the chapter before can with devices with a software starting from 11/2004 by the non linear Speed Compensation (NLT) simplified be entered. You need only one cam or a shift register output of the SPS - logic - becomes module with NLT - speed compensation.

For this you have to define in the CamCon a table with speed compensation - and velocity values.

To the right you see a characteristic curve with 5 base points.

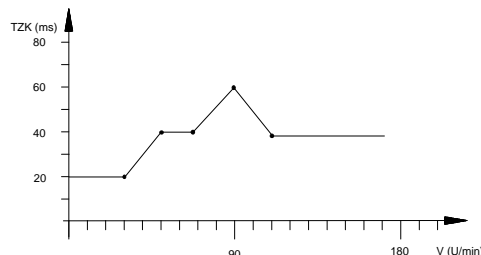

2.1.4. Separate delay time for Speed Compensation of switch-ON and switch-OFF points

For CamCon devices of Software from 3/2002 Speed Compensation is now available for separate switch-ON and switch-OFF points. This is necessary since some valves need longer to switch OFF than to switch ON.

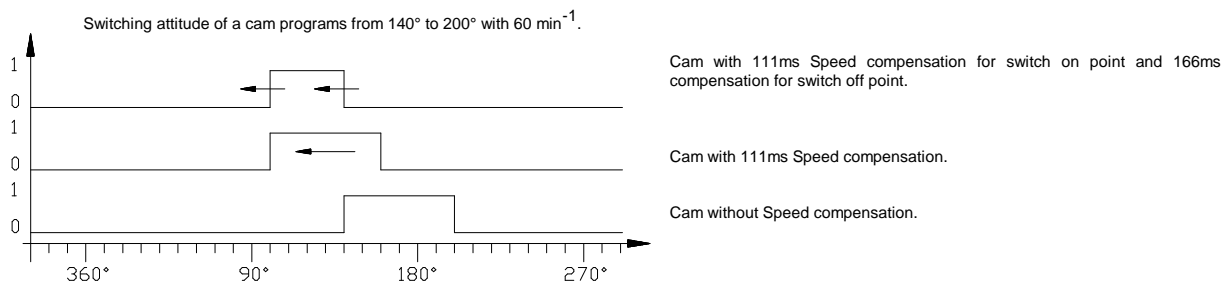

For the calculation of both delay times the same formuli are used as for a *normal* compensation. See Chapter "2.1.1. Measuring delay time for Speed Compensation" on page 10 for entering delay time see Chapter "6.5.2. Entering the Speed Compensation" on page 31.

Attention: If the switch-off-point of a Cam overtakes the switch on point at rising speed, the result will be an non-defined signal.

2.2. Time - Cam

With normale cam becomes with increasing plant speed switch-on time ever more briefly. If controlling a glueing-station, the result would be an insufficient ammount of spreaded glue.

A Time - cam however has with each plant speed a firm temporal length, so that exactly the same ammount of glue could be spread at changing speeds. The switch-on point of the Cam on a *normal* as well as on a Time-Cam is appointed by a position-dependent Position value and a delay-time/speed compensation.

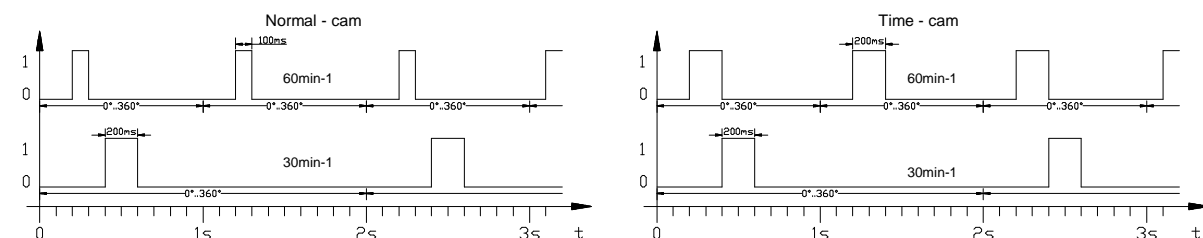

For CamCon devices of software releases after 3/2002 Time Cam is also available for devices without PLC - Logic - Module.

For entering a Time - Cam see Chapter "6.5.2. Entering the Speed Compensation" on page 31.

3. Installation

The device is snapped onto an "EN - carrier rail" in the switchboard (see chapter "3.1. Dimension" on page 13). The grounding connections and the cable coverings are to be put on the shortest possible way on the serial grounding clip next to the device. The grounded assembly plate and its electrical connection to the "EN carrier rail" allow an excellent grounding of the disturbances onto the covering. All cable connections are to be switched in a cold state ! If your CamCon has an external interface, it is connected to the "ext.Int. IN" plug at the CamCon module (e.g. DAC16, DC16/IO, DC91/IO or DC92/I) with a cable of the type: KKyy/IO-XX (yy = CamCon Type / XX = Length in meters). The data lines of the external interface are galvanically separated through an optical coupler, they have to be covered, and the cover has to be grounded on both ends. The connection cable (for the measuring system or the serial interface) also has to be covered, and the cover has to be grounded on both ends. Analog signals have to be covered, and the cover has to be grounded on one end.

3.1. Dimension

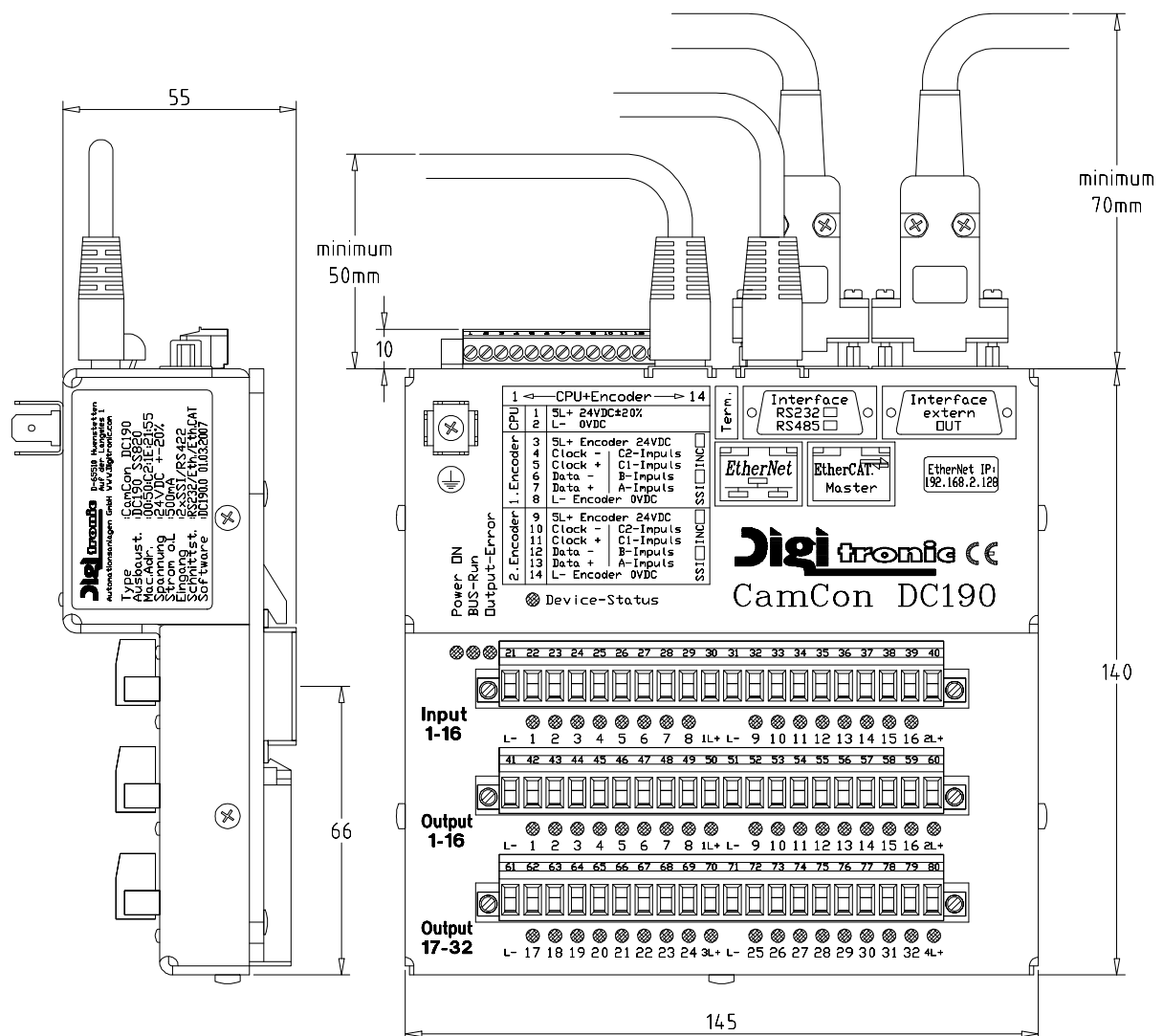

4. Electrical connections

Before you begin with wiring, please consult the following chapters: "4.7. Outputs" on page 24, "4.8. Inputs" on page 24 and "4.6. The measuring system" on page 20.

4.1. Pin allocation of the CamCon

4.1.1. Pin allocation of the power supply

Pin 1: +24V DC power supply (5L+)
Pin 2: 0V power supply (L-)

4.1.2. Pin allocation of 1. Measuring System - Input

4.1.2.1. Pin allocation of SSI Measuring System

Pin 3: +24V DC power supply of the Measuring System (5L+)
Pin 4: Clock B or -
Pin 5: Clock A or +
Pin 6: Data B or -
Pin 7: Data A or +
Pin 8: 0V power supply of the 1. SSI the Measuring System (L-)

4.1.2.2. Pin allocation of the incremental Measuring System (optional)

Pin 3: +24V DC power supply of the incremental Measuring System (5L+)
Pin 4: Clear 2
Pin 5: Clear 1
Pin 6: B Impulse
Pin 7: A Impulse
Pin 8: 0V power supply of the incremental Measuring System (L-)

4.1.3. Pin allocation of the 2nd Measuring System input

4.1.3.1. Pin allocation of the 2nd SSI Measuring System

Pin 9: +24V DC power supply of the 2nd Measuring System (5L+)
Pin 10: Clock B or -
Pin 11: Clock A or +
Pin 12: Data B or -
Pin 13: Data A or +
Pin 14: 0V power supply of the 2nd SSI Measuring System (L-)

4.1.3.2. Pin allocation of the 2n incremental Measuring Systems (optional)

Pin 9: +24V DC power supply of the 2nd incremental Measuring System (5L+)
Pin 10: Clear 2
Pin 11: Clear 1
Pin 12: B Impulse
Pin 13: A Impulse
Pin 14: 0V power supply of the 2nd incremental Measuring System (shaft encoder) (L-)

Note: You can determine which kind of Measuring System input (SSI or INK) you are using by checking the markings on the DC190 housing

Attention: Pins 1, 3 and 9 are connected with each other within the unit (5L+).
Pins 2, 8, 14, 21, 31, 41, 51, 61 are connected with each other within the unit (L-).

4.1.4. Pin allocation of Inputs 1 - 16

Pin	21:	0V Input signal ground (L-)
Pin	22:	Input 1
Pin	23:	Input 2
Pin	24:	Input 3
Pin	25:	Input 4
Pin	26:	Input 5
Pin	27:	Input 6
Pin	28:	Input 7
Pin	29:	Input 8
Pin	30:	+24V DC Output power supply for outputs 1 - 8 (1L+)
Pin	31:	0V Input signal ground (L-)
Pin	32:	Input 9
Pin	33:	Input 10
Pin	34:	Input 11
Pin	35:	Input 12
Pin	36:	Input 13
Pin	37:	Input 14
Pin	38:	Input 15
Pin	39:	Input 16
Pin	40:	+24V DC Output power supply for outputs 9 - 16 (2L+)

4.1.5. Pin allocation of Outputs 1 - 16

Pin	41:	0V Output power supply for outputs 1 - 8 (L-)
Pin	42:	Output 1
Pin	43:	Output 2
Pin	44:	Output 3
Pin	45:	Output 4
Pin	46:	Output 5
Pin	47:	Output 6
Pin	48:	Output 7
Pin	49:	Output 8
Pin	50:	+24V DC Output power supply for outputs 1 - 8 (1L+)
Pin	51:	0V Output power supply for outputs 9 - 16 (L-)
Pin	52:	Output 9
Pin	53:	Output 10
Pin	54:	Output 11
Pin	55:	Output 12
Pin	56:	Output 13
Pin	57:	Output 14
Pin	58:	Output 15
Pin	59:	Output 16
Pin	60:	+24V DC Output power supply for outputs 9 - 16 (2L+)

Attention: Pins 30 and 50 are connected with each other within the unit (1L+).
Pins 40 und 60 are connected with each other within the unit (2L+).
Pins 2, 8, 14, 21, 31, 41, 51, 61 and 71 are connected with each other within the unit (L-)
Pins 2, 41, 51, 61 and 71 always have to be connected.

4.1.6. Pin allocation of outputs 17 - 32

Pin	61:	0V Output power supply for outputs 17 to 24 (L-)
Pin	62:	Output 17
Pin	63:	Output 18
Pin	64:	Output 19
Pin	65:	Output 20
Pin	66:	Output 21
Pin	67:	Output 22
Pin	68:	Output 23
Pin	69:	Output 24
Pin	70:	+24V DC Output power supply for outputs 17 to 24 (3L+)
Pin	71:	0V Output power supply for outputs 25 to 32 (L-)
Pin	72:	Output 25
Pin	73:	Output 26
Pin	74:	Output 27
Pin	75:	Output 28
Pin	76:	Output 29
Pin	77:	Output 30
Pin	78:	Output 31
Pin	79:	Output 32
Pin	80:	+24V DC Output power supply for outputs 25 to 32 (4L+)

Attention: Pins 2, 8, 14, 21, 31, 41, 51, 61 and are connected with each other within the unit (L-).
Pins 2, 41, 51, 61 and 71 always have to be connected.

4.2. PIN - Allocation of the Serial Interface

When ordering the CamCon DC190, you can select between two types of serial interface: Options are the RS232 or the RS485. Depending on the type of interface used, the pin allocation and the wiring varies.

Note: You can determine which kind of interface your device uses by checking the markings on the DC190 housing.

4.2.1. PIN - Allocation of the Serial Interface RS232

DSUB 9 male: RS232 interface for the connection with a PC (max. 15m cable length)

Pin	2	TxD
Pin	3	RxD
Pin	5	Ground
Pin	1, 4 and 6 - 9	not connected (NC).

Example: Connecting cable / order No.: KK33-190 2-03

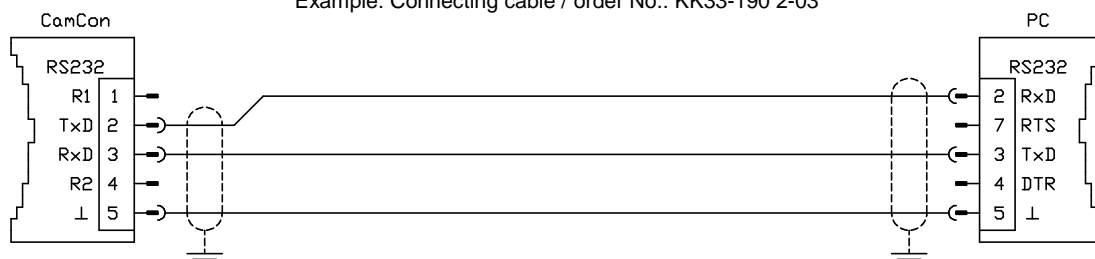

Attention: The DIP - switch (Term.) for the RS485 load resistors must **never** be shut (ON) when using an RS232 interface.

4.2.2. PIN - Allocation of the Serial Interface RS485 (Optional)

DSUB 9 male: RS485 interface for the connection with a PC or other DC190 units (max. 1000m cable length).

Pin	2	B (-)
Pin	3	A (+)
Pin	5	Ground
Pin	1, 4 and 6 - 9	Not connected (NC).

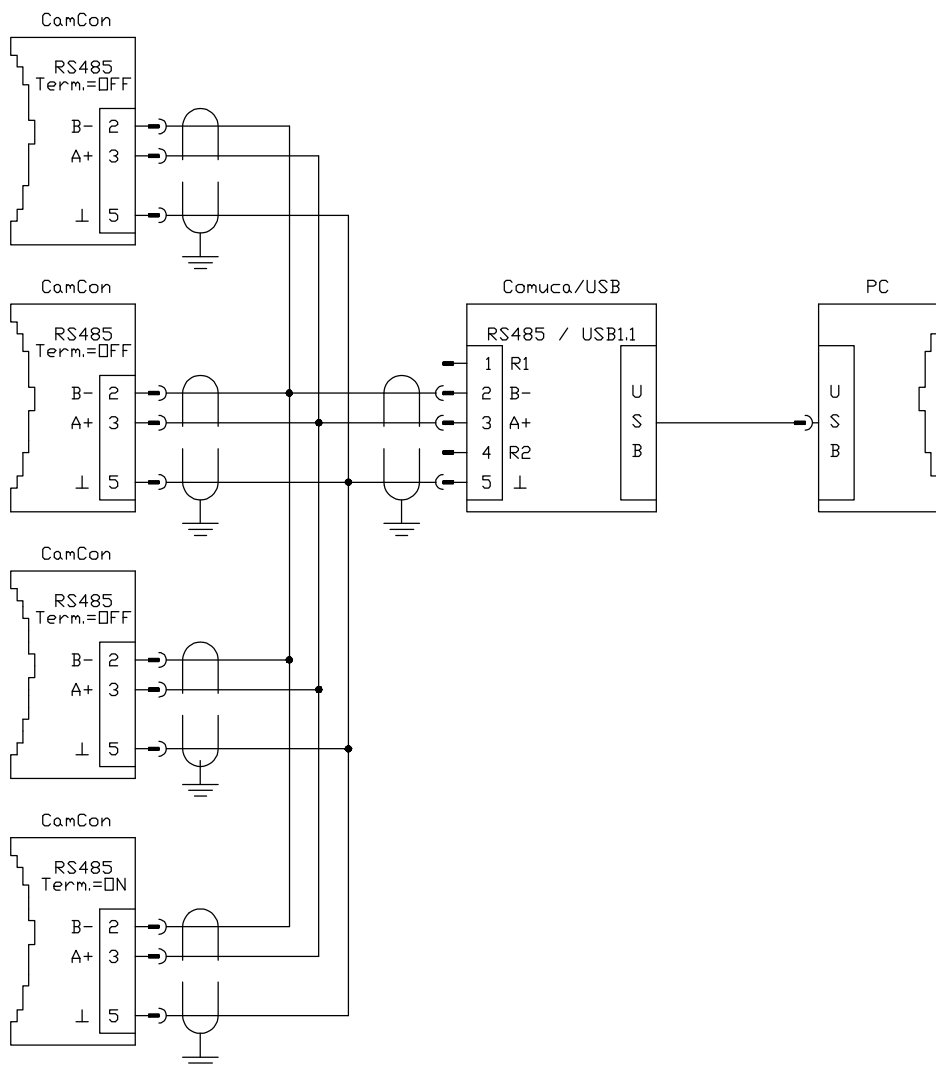
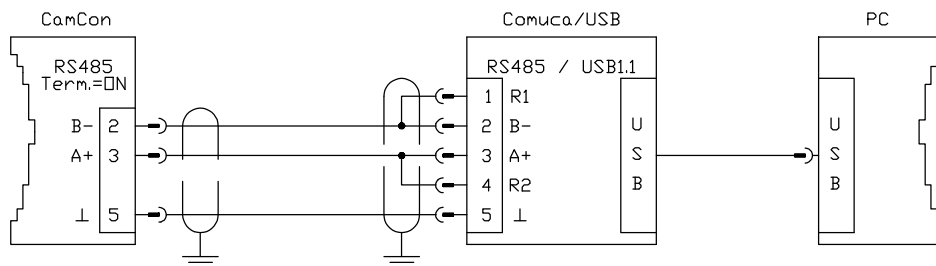

Regard: When using the RS485 interface, the first and last units in the chain have to have their data transfer cables closed with a terminal resistor. See also next chapter.

4.2.2.1. Terminal Resistors of the RS485 Interface

To switch the terminal resistors of the CamCon DC190 on or off, a bipolar DIP – switch (labeled “Term”) on the unit can be actuated using a screw driver. If the switches are closed (ON), the RS485 - wiring is shut with a terminal resistor of about 2300/220/3200 Ohm. Therefore, always use both switches simultaneously, otherwise the unbalanced load can disturb the data transmission.

Attention: If the CamCon DC190 is equipped with an RS232 interface (factory setting), the DIP – Switch must **never** be shut (ON).

4.3. PIN - Allocation external Interface

The CamCon DC190 has an external interface with the option to expand the unit with a CamCon DC91/IO -, DC92/I -, DC16/IO – or AWA Analog/Digital Module. Expansion modules can easily be snapped onto the mounting rail in the cabinet and connected with a 6 pole KK190/IO-XX cable using the CamCon’s 9 pole D-sub pin-plug "external Inter. in" (max. 30m cable length). The data is transferred isolated and potential free via optocouplers. A connecting cable for the DC190 with a DSUB ribbon cable connector can be ordered using order No. "KK190-16/IO-XX" with XX being the cable length in meters.

DSUB 9 female: Connector for external in- and output modules like the DC91/IO or DC16/IO.

Pin 1,4,7	Ground
Pin 2	TxD +
Pin 6	TxD -
Pin 8	CLK +
Pin 3	CLK -
Pin 5	RxD +
Pin 9	RxD -

Connector cable CamCon DC91/IO:

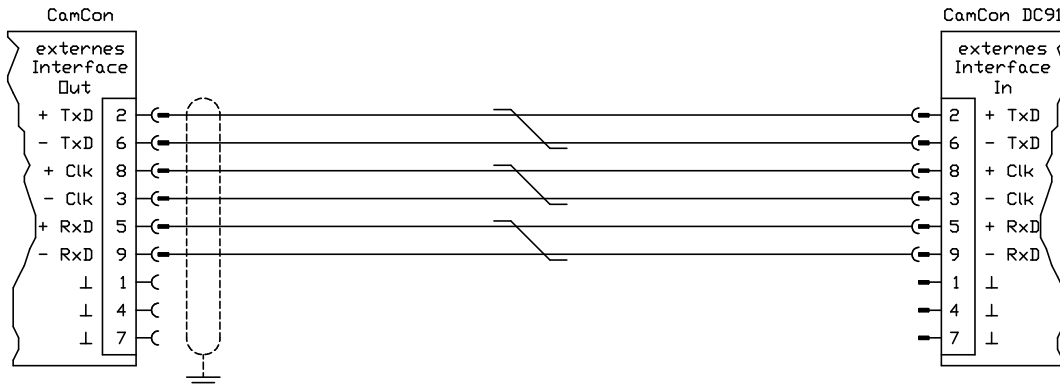

Connector cable CamCon DC16/IO:

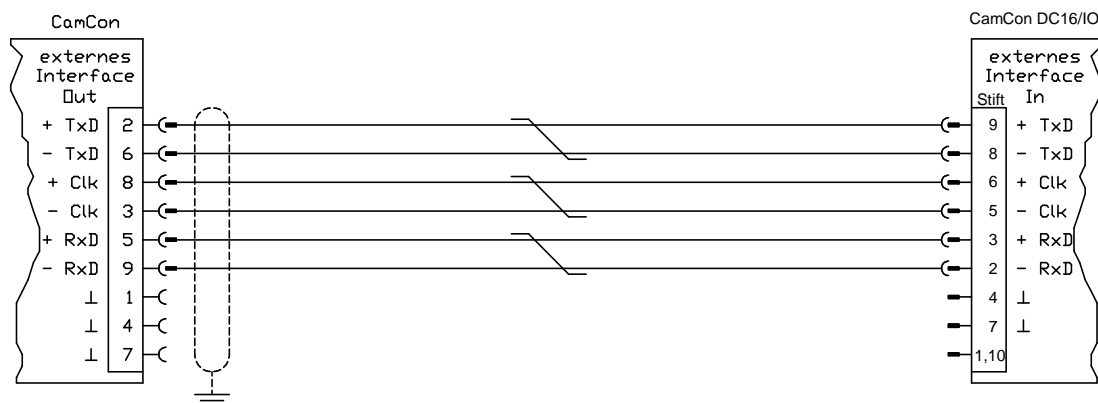

4.4. Connecting the Ethernet Interface

Connecting the CamCon to the EtherNet or local area network is done using a RJ45-connector (Registered Jack) and a standard EtherNet Cat.5 cable with 10/100 Mbit.

The Connector is switched as following:

Pin 1	TxD	+
Pin 2	TxD	-
Pin 3	RxD	+
Pin 4	-	
Pin 5	-	
Pin 6	RxD	-
Pin 7	-	
Pin 8	-	

Connect the network interface card of your PC using a cross over EtherNet cable directly with the DC190 or via a standard EtherNet Cat.5 cable with an additional switch, that can be connected with the DC190 using a second EtherNet Cat.5 cable.

4.5. Connecting the EtherCAT Interface

The standard connection to the EtherCAT terminal uses a RJ45 – connector (Registered Jack) and a standard EtherNet Cat.5 cable with 100 MBit transmission rate.

The Connector is switched as following:

Pin 1	TxD	+
Pin 2	TxD	-
Pin 3	RxD	+
Pin 4	-	
Pin 5	-	
Pin 6	RxD	-
Pin 7	-	
Pin 8	-	

Connect the EtherCAT Master-Interface of the CamCon DC190 with a standard EtherNet Cat.5 cable to an EtherCAT Slave terminal like the Beckhoff EK1100 at the RJ45 jack labeled "IN" or with a CamCon DC190 IO EtherCAT Slave at the same connector.

Note: Do not set up the EtherCat cables next to strong electro-magnetic disturbances (like motor cables or power lines). To increase the electromagnetic compatibility, you can equip the EtherCAT cables with additional ferrite bead suppressors or separately ground the EtherCAT cables shielding.

4.6. The measuring system

The measuring system is designed to record the necessary actual values (positions) for the Cam Switch Unit. Many different measuring system can be linked with the CamCon.

See chapter "4. Electrical connections" on page 14 and for adjustment of the measuring system to the software of the CamCons please also consult Chapter "6.6.1. Measuring system" on page 32.

Note: Please also consult the instruction manual for your measuring system.

4.6.1. SSI Measuring system input

Systems with a synchronous series interface = SSI. The SSI interface is widely used in industry for absolute single and multi-turn angle encoder. At this interface the CamCon supplies the measuring system with 24Volt. For the purpose of data reading the CamCon sends a stroke signal (clock) with RS422 level to the measuring system. This answers synchronously with the data output of the position in the grey code. The frequency of the pulse signal depends on the length of the cable to the measuring system and can be set in the CamCon.

Note: The data record corresponds to the Stegmann SSI Standard!

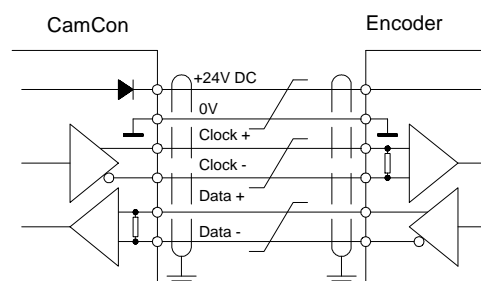
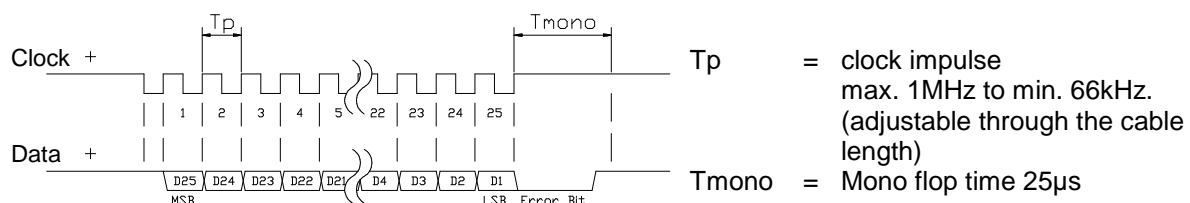

Please note:

Use a screened dual strand connection cable. Do not place the cable parallel to a high voltage cable. If possible, lay the screening down on both sides.

4.6.2. Parallel measuring system input

Systems with parallel 24V data leads, e.g. single turn - angle encoder or via a transformer with parallel data output.

In this instance a gray or binary encoded value is attached to the free inputs of the CamCon and this will be read as actual value. Since the connection cable are quite expensive and the EMV - compatibility is limited, this interface type is rarely used in industry nowadays.

Note: Since the outputs are partly switched parallel to the inputs in CamCon DC16, DC115, DC300 and CamCon 1756-DICAM, these must not be programmed under any circumstances and this reduces the number of available outputs.

Warning: Reading a binary encoded value into the CamCon is only permitted after consultation with the Service department of the company Digitronic.

4.6.3. Incremental measuring system input

Systems with 90° phase shift signals such as turning angle encoders, glass measuring rods or flow measuring devices.

At the present time incremental measuring inputs for the CamCon DC16/50/51/115/300 and DC1756 are available as an option. We differentiate between three signal levels:

- 24V PNP Signal inputs (Order number Option: J)
- 5V RS422 Signal inputs (Order number Option: I)
- Hiperface Signal inputs (Order number Option: H)

Note: For the CamCon DC16 and DC300 only the version with 24V PNP signal is available. For the CamCon 1756-DICAM the version with 24V PNP signal and Hiperface Signal is available. If a different signal level is necessary, this can be converted externally with the INCDRV converter.

In all cases the CamCon supplies the measuring system with 24Volt/DC or in CamCon DC115 optionally with 5 or 24Volt/DC. As a counting signal the measuring system gives out two impulses at a time shifted by 90°. These are counted in the CamCon and are evaluated as position values. In addition, for each rotation another zero impulse (Clear 1) is given out for synchronisation purposes. In order to stop synchronisation (zero setting) of the counter, a further clear signal (Clear 2) is available on the CamCon.

The signals Clear 1 and Clear 2 are to standard AND linked and can be changed in their function with the software. See Chapter "6.6.1.6.3. Special measuring system - Incremental" on page 35

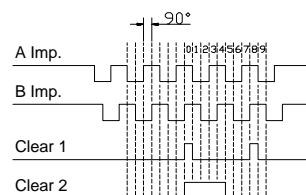

4.6.3.1. Incremental measuring system input with 5V RS422 level

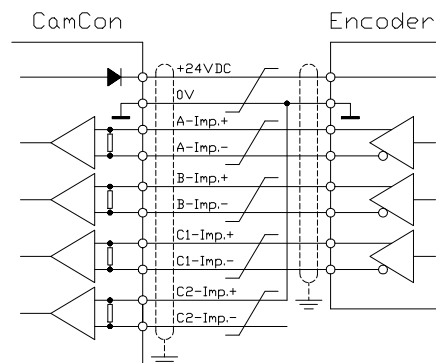

If the 5V RS422 system is used, all signals of the measuring system input must be active, otherwise the input conditions are undefined. If no signal is available for one of the two Clear inputs, then this input must be switched to mass on the (+) signal in order to switch the input to low. The inputs of the measuring system can be activated with a maximum voltage of 5V. Please pay attention to the power supply of the angle encoder which can be 5V as well as 24V. Only the CamCon DC115 can at present provide a voltage of 5V for the supply of the angle encoder.

4.6.3.2. Incremental measuring system input with 24V PNP level

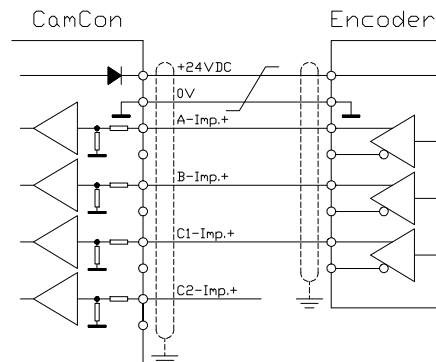

If a 24V PNP signal is used for data input, then only the (+) signals of the inputs may be connected. The (-) signals must stay inactive in this case. The connection of such a measuring system requires a change of the internal switch system and must therefore be stated on the order form.

Note: At the incremental input of the CamCon DC16, DC300 and DC1756 no (-) signals are available.

4.6.3.3. Incremental Hiperface measuring system input with SINCOS level

The Hiperface measuring system is a feedback system for servo-motors of the company Stegmann.

It is a mixed system and consists of an absolute measuring system and an incremental measuring system. The absolute measuring system sends its values via RS485 interface to the counter. The incremental measuring system works with analog sine - and cosine interface with a resolution of 512 or 1024 impulses per revolution.

The CamCon with the Hiperface signal input (option: H) reads only the incremental sine - and cosine signal. The signals are converted and counted in the CamCon into normal incremental measuring system signals.

Since the absolute measuring system of the Hiperface interface is not used and no clear - signals are available, the CamCon must be initialized after each restart.

This must be done by the preset input of the CamCon. See for this to chapter 6.6.2. Measuring offset on page 40.

Note: The maximum number of revolutions per minute is 3000 min^{-1} with 512 Impulse per revolution. The maximum number of revolutions per minute is 1500 min^{-1} with 1024 Impulse per revolution.

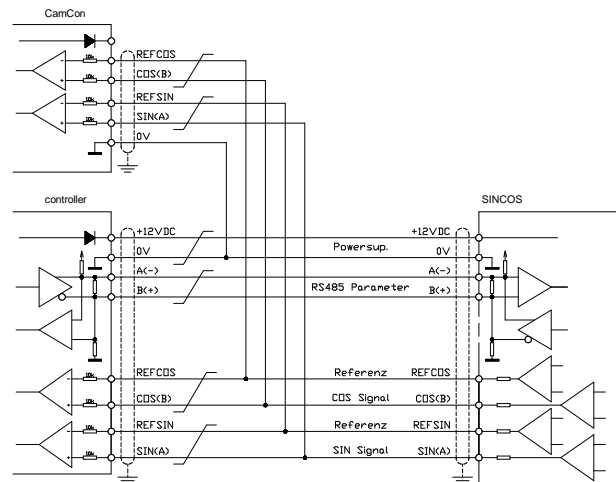

4.6.4. Analog measuring system input

These are systems which receive their actual value through conversion of current or voltage signal, such as temperature or pressure sensors.

For the recording of analog signals the analog to SSI conversion module AWA/SSI in 8 and 12 bit resolution is available for the CamCon. This module is connected to the SSI of the CamCon and is switched ON through the selection of the analog measuring system in the menu "Measuring system".

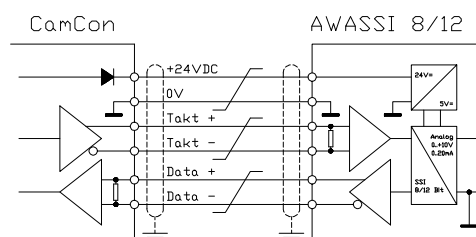

4.6.5. PLL measuring system input

Systems with Phase - Lock - Loop data recording. In these systems the actual value is found through interpolation of initiator impulses. This measuring system is applied to machines with constant speed and with a cyclic pulse.

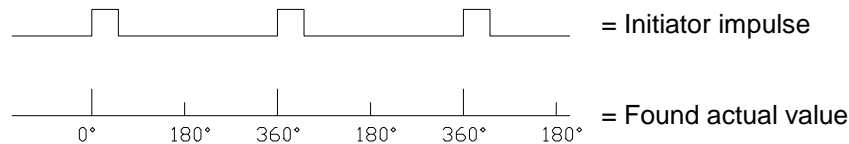

The Initiator can be connected to any free input of the CamCon.

Note: For CamCon DC115 a special input is available on the 25pol. SUB-D plug.

See also chapter "6.6.1.6.5. Special Measuring System - PLL" on page 37.

4.6.6. Timer as a measuring system

Systems which are controlled by elapsed time. In this case the CamCon makes a time available with a time basis of minimum 1 ms as actual value. Through laying on of input signals it is possible to influence the elapsed time. This measuring system is applied to machines with a fixed time scanner as a control feature, e.g. washing machines.

See also chapter "6.6.1.6.6. Special measuring system - Timer" on page 37.

4.6.7. RS232 as a measuring system

Systems, receiving their actual position through the RS232 interface, e.g. for a junction of a Stegmann POMUX linear scale to a RS232 data output.



Warning The activation of this measuring system blocks the RS232 interface for programming. This measuring system is only reasonable with a CamCon DC50/51.

4.7. Outputs

The CamCon DC190 features 32 on board short circuit proof outputs. They deliver 24 volt high-active HTL signal with 0.5 amps steady current (100%ED). They are, nevertheless, not potentially free to the unit's or the CPU's power supply.

The 32 outputs are gathered in four blocks of eight outputs each and have a separate power supply (1L+ to 4L+), that can be switched on or off individually.

See also chapter "6.6.6. System upgrading" on page 47.



Attention: Inductive Reactances always have to be switched with a recovery diode!

4.8. Inputs

The CamCon DC190 features 16 on board inputs with active 24 volt signal (not potentially free). The number of inputs can be increased by adding an external interface or an EtherCAT BUS up to 248 inputs.

The input wiring:

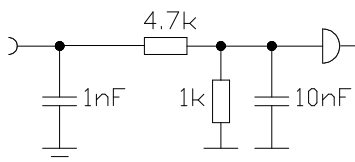

The input resistance is about 5.7 KOhm.

The inputs of the CamCon have not been covered with functions by the factory. The user would have to do this himself in the process of setting system data of the CamCon depending on his requirements. See chapter "6.6.6. System upgrading" on page 47, chapter "6.6.1. Measuring system" on page 32, chapter "6.6.6. System upgrading" on page 47 and chapter "6.6.6. System upgrading" on page 47.

4.9. Precautionary measures for welding work

Attention: For the duration of welding operations carried out at the machine, the connecting wires concerning the data exchange from the measuring system to the CamCon and the power supply as well as the grounding connections and inputs and outputs have to be separated from the CamCon.



4.10. Status Display

The CamCon DC190 features several status displays: 32 output indicators, 16 input indicators, 5 indicators for the power supply (1..5L+), one display for the internal DC190 BUS (BUS-Run), one for output-errors or overload, one DC190 Status LED (Device-Status) and status LEDs for EEtherNet and EtherCAT (Link and active).

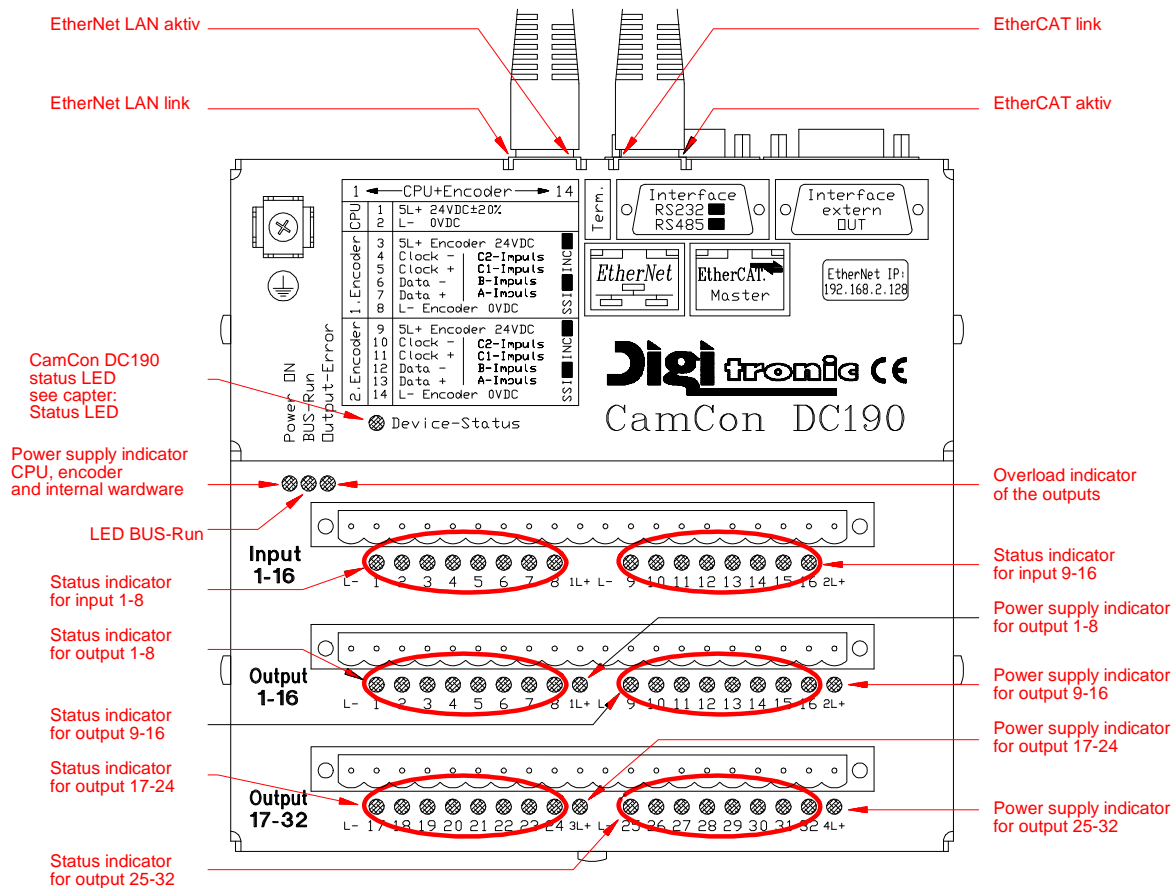

- The BUS-Run LED BUS-Run indicates that the CamCon DC190 CPU has contact with in- and outputs. If the LED does not light up, it is because of an error or a restart process or a startup is interrupted and the DC190 cannot be started.
- The Ethernet LAN Link LED indicates a successful connection to the switch or EtherNet-card.
- The Ethernet LAN Active LED shows that data can be transmitted.
- The EtherCAT Link LED indicates the connection to an EtherCAT terminal like a Beckhoff EK1100 or a CamCon DC190 IO.
- The EtherCAT Active LED shows the transmission of I/O data.
- The LED Output-Error indicates an output overload by short circuits or a too high load or temperature.

4.10.1. The DC190 Status LED

The status LED of the CamCon shows the different blinking intervals of the the device state. This way, the operation state of the device can be seen without a PC or a terminal.

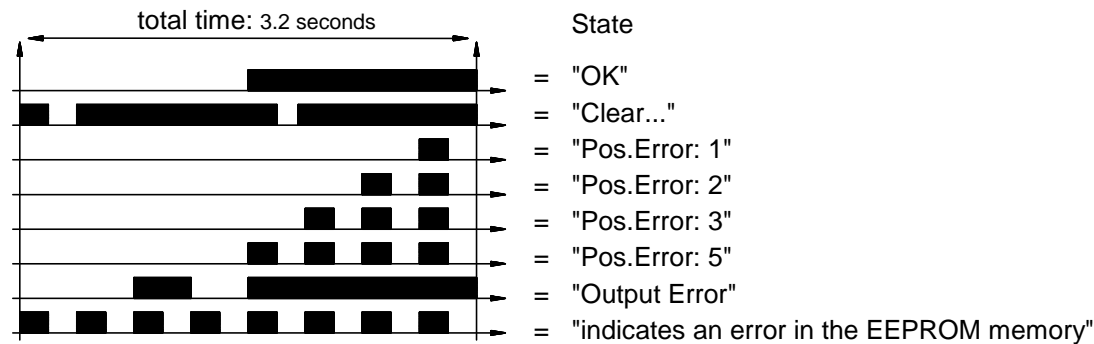

See also chapter "8. Error messages and removal of errors (FAQ)" on page 56.

5. Commissioning

Please check the device's wiring before you switch it on. See also chapter "4. Electrical connections" on page 14 for hints.

Attention: *Inductive Reactances always have to be switched with a recovery diode! Inductors or contactors that are mounted in proximity to the DC190 or the wiring of which could affect the unit must be switched with RC elements.*



The CamCon acknowledges the start-up with a flashing Status LED. After an internal check-up, the system is booted (e.g. the EEPROM's checksum is determined as is the Flash's). This procedure takes a few seconds.

The CamCon DC190 can be programmed via the EtherNet TCP/IP interface, the integrated Web server DigiWEB or a Web-Browser like Internet Explorer or FireFox. It is therefore necessary to know or set the unit's correct IP-address.

5.1. Setting the IP-Address

Attention: Any IP – address must only be given once within a LAN. If you do not know any free IP, please necessarily contact your network administrator before you connect the DC190 to the network.

The factory setting of the device's IP address is 192.168.3.128 / 255.255.255.0.

Should you decide to use another address, take down the MAC address of your CamCon (see type plate) first (e.g. 00:50:C2:1E:21:6C).

Connect the CamCon with a CAT5 Ethernet Cable with a switch of your LAN or connect it via a Cross – Over – Cable with the RJ45 Connector of your PC's network card. Now open a command prompt (e.g. by typing CMD in the "Run" command line in Windows).

```

C:\WINNT\system32\cmd.exe
C:\>ipconfig

Windows 2000-IP-Konfiguration

Ethernetadapter "LAN-Verbindung":
    Verbindungsspezifisches DNS-Suffix:
    IP-Adresse . . . . . : 192.168.2.41
    Subnetzmaske . . . . . : 255.255.255.0
    Standardgateway . . . . .
    
```

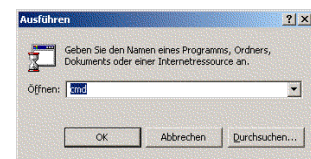

Now type the command "ipconfig" in the command prompt, to determine your computer's IP and subnet mask.

If no IP address or subnet mask is displayed here or the IP is displayed as 0.0.0.0, a network connection is not yet set or set incorrectly. Please contact your network administrator if necessary.

In our example the IP-address is 192.168.2.41 while the subnet mask is shown as 255.255.255.0. That would indicate that the DC190's IP must be configured within the range of 192.168.2.1 to 192.168.2.254. It must, nevertheless, not be identical to the IP of the computer itself. You could use, for example, the IP 192.168.2.128. or similar.

If the IP address is 169.254.148.76 (for example when using a cross over cable) and the subnet mask 255.255.0.0, the CamCon DC190 can be configured within an address range of 169.254.0.1 up to 169.254.254.254. It must **never** equal the computer's IP (like 169.254.148.75, for example).

If you know of a free address in the network or the administrator assigned one for you, you can continue with the setting of the IP.

For this purpose, enter the CamCon's MAC – Address (Media - Access - Control) using the command "arp" in your system's network card.

For the MAC address "**00:50:C2:1E:21:6C**" (e.g.) the correct command would be:

arp -s 169.254.148.75 00-50-C2-1E-21-6C or **arp -s your.ip.address.please your-MAC-Address**

Note: Windows uses hyphens instead of colons !

To activate the IP address in the CamCon and to check the connection between device and computer, deactivate the firewall first, then set the following command: "**ping 169.254.148.75**" respectively "**ping your.ip.address.please**"

The answer should look like this:

If the ping was successful, the set IP address can be used until the next system restart of the computer. The IP address is only temporary!

To set a permanent IP address, you have to use the CamCon DC190's network configuration. Open a web browser and type in the following address:

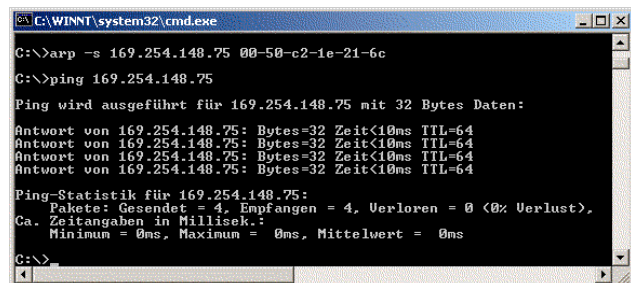

```
C:\WINNT\system32\cmd.exe
C:\>arp -s 169.254.148.75 00-50-c2-1e-21-6c
C:\>ping 169.254.148.75
Ping wird ausgeführt für 169.254.148.75 mit 32 Bytes Daten:
Antwort von 169.254.148.75: Bytes=32 Zeit<10ms TTL=64
Antwort von 169.254.148.75: Bytes=32 Zeit<10ms TTL=64
Antwort von 169.254.148.75: Bytes=32 Zeit<10ms TTL=64
Ping-Statistik für 169.254.148.75:
    Pakete: Gesendet = 4, Empfangen = 4, Verloren = 0 (0% Verlust),
    Ca. Zeitangaben in Millisek.:
    Minimum = 0ms, Maximum = 0ms, Mittelwert = 0ms
C:\>
```

"http://169.254.148.75/config.htm" respectively "**http://our.ip.address.please/config.htm**"

Note: Depending on the LAN, there is possibly an HTTP proxy server set for the browser. Check the menu extras -> internet options -> connections -> LAN settings (IE) or extras -> options -> extended -> network -> connections (FF). This HTTP proxy must be switched off or the CamCon DC190's IP must be configured as an exception for which the proxy server is not used.

After a login procedure (for which a user: **ftp** and a password: **ftp** is used) you can configure the CamCon DC190 or the DigiWEB in respective.

For this purpose, set the desired IP the subnet mask and (if needed) a gateway.

Other parameters are not needed to use the DC190 as a cam controller. They are explained in detail in the manual of the DigiWEB webserver.

Pressing the **OK** button saves the IP in the CamCon's permanent memory for future use.

To access the programming interface of the CamCon, type the unit's new IP (e.g. **http://192.168.2.101**) into your browser address line.

The picture on the following page will be displayed.

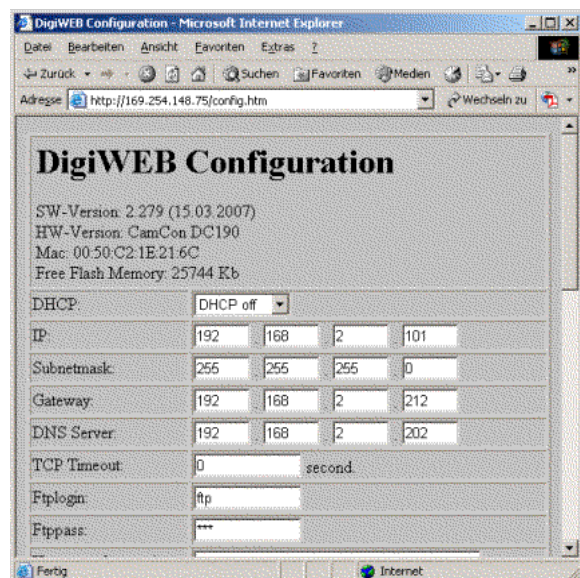

6. Programming

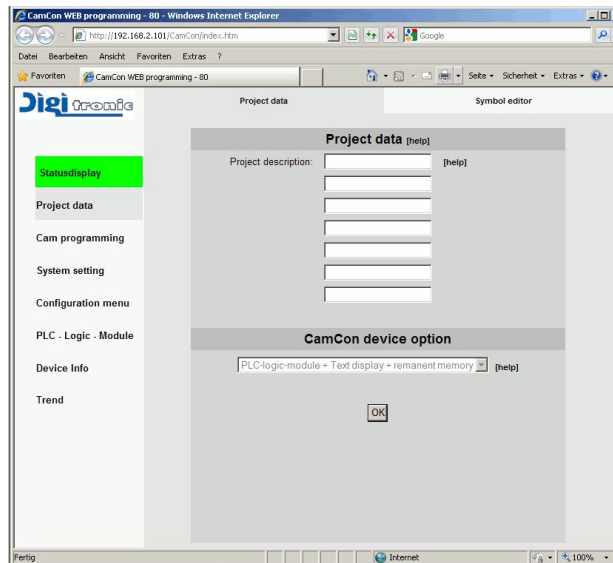

Note: The Web programming requires Java Script and ActiveX (Internet Explorer Only). Any popup-blocker must be deactivated for the CamCon's IP address!

6.1. Deleting the Cam Control

The cam control's memory should be deleted for commissioning, since remains of testing programs needed in the manufacturing process, still are present within the memory. It is nevertheless possible to delete the memory later or at any time to reset the device to its initial state.

Attention: *It is not possible to restore deleted memory!*



To delete the memory, use the memory:

"Configuration menu" -> "Configure unit" -> "Format unit"

After a safety request the cam controller's memory will be deleted completely. All cams are deleted, all system register are set back to standard.

You can then begin with programming.

To activate the unit at your machine, a minimum of parameters must be set for the CamCon. The following order our suggestion for setting the parameters – the required procedure can be found in the corresponding chapters.

- 1) Menu: **"Configuration menu" -> "Configure hardware"** see chapter "6.7.1. Configure hardware"
- 2) Menu: **"System setting" -> "System upgrading"** see chapter "6.6.6. System upgrading"
- 3) Menu: **"System setting" -> "Cable length"** see chapter "6.6.4. Cable length"
- 4) Menu: **"System setting" -> "Measuring system"** see chapter "6.6.1. Measuring system"

After the corresponding entries have been made, the CamCon should be ready for service.

Of course we recommend to work through the complete configuration menu to get a maximum handling and functional options.

After the cam controller is configured, the cams can be programmed.

If you want to use the CamCon cam switch as a cam controller with PLC logic option, set the PLC-Logic option in the **"Configuration menu"**, using the **"PLC configuration"** menu. The cam outputs can be switched to e.g. the inputs using the menu **"PLC - Logic - Module"**.

6.2. The Main Menu

Every configuration starts in the main menu. No matter what sub menu you are in, the main menu helps you to access every other menu with just one click.

The recently selected menu is highlighted.

According to the menu configuration the look of the main menu can vary. Options can be missing or additional options can be available (like e.g. tool protection).

The recent status of the unit is indicated by a green (OK) or red (error!) highlight of the "Status Display" option. One further click gives you access to a more detailed error report.

By clicking the Digitronic logo you can get information on the used firmware version, the DigiWEB version, the DigiWEB webpage version and the instance and port number of the webpage.

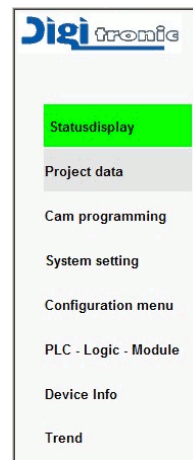

6.3. Statusdisplay

Access the status display (pop-up) by clicking "Statusdisplay",

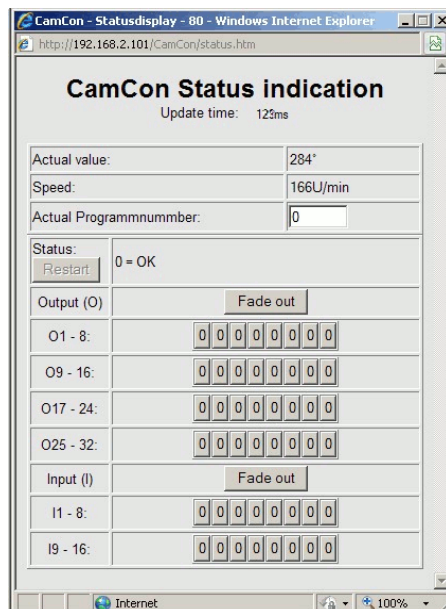

showing the actual value, the recent speed, a program number as well as any potential error message but also the status of all outputs, inputs, cams, flags and other signals.

To increase the display speed or to decrease the update speed, use the "Fade out" option to mask the respective block from the display.

Error messages can be easily acknowledged by clicking "Restart".

If an error can only be cleared by a total deletion, a security request precedes the delete.

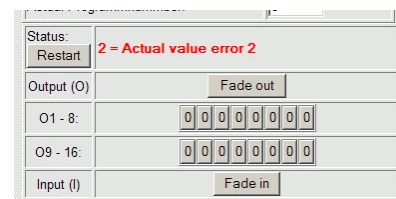

6.4. Project data

Here you can save general information about your machine in the CamCon's memory (like e.g. machine number or output conditions). For these purpose, there are seven lines with 21 characters each available.

6.4.1. CamCon device option

Currently, you can order the CamCon with four options:

1. PLC - Logic - Module (S).
2. PLC - Logic - Module with text display (M).
3. PLC - Logic - Module with text display and remanent memory (C...M).

Note: "Remanent Memory" is used to secure counter value and flags against power shortages. For this option, the hardware configuration EEPROM – Memory Extension "C" is mandatory. This optional hardware is included as a standard in the CamCon190.

4. PLC – Logic - Module with text display and Tool Protection (W).

Select available options for your CamCon in this menu. The type plate indicates all installed options in the last digits of the order number: 0 = none selected / S = PLC – Logic - Module / M = PLC – Logic - Module with text display / W = PLC – Logic - Module with text display and Tool Protection. The optional remanent memory is indicated by the character C in the memory extension (e.g. DC51 S5C24002M, DC16 S5C04S or DC190 SS82W).

6.4.2. Offline - Simulation

The Digisoft 2000 Program gives you the opportunity to simulate the encoders like the Measuring System, hardware inputs (I) and backplane inputs (V) of an S7 (CamCon DC300 or ControlLogix 1756-DICAM) in the "Offline" programming. This option makes it possible to test a PLC logic program on your computer without having to install a CamCon or further machinery. This option is not available "Online". The Digisoft 2000 program can be downloaded at <http://www.digitronic.com>.

6.5. Cam programming

Cam programming is used to select a program number for the programming of a cam. You can name any program number (with a tool or recipe number, e.g.). Programmed cams are displayed graphical on a scale in the resolution of the used measuring system. Maximum and minimum values (actual or cam values) will be displayed to the left and right above the scale (e.g. 0° - 359°).

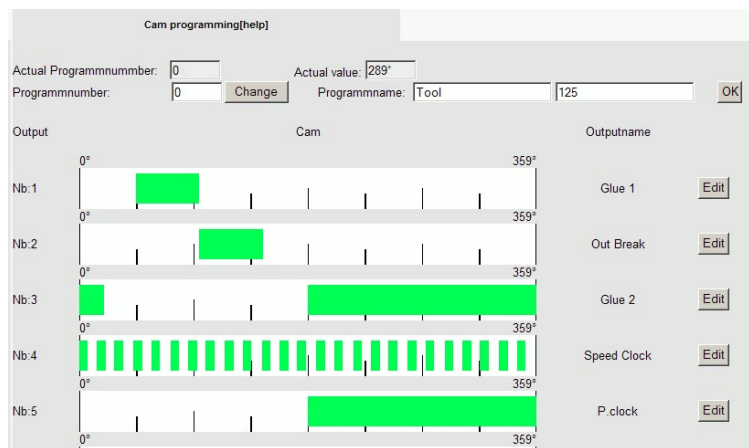

You can access the programming options by clicking the "Edit" button.

6.5.1. Entering Cams

The cam programming can be used to address a name to any cam output, to enter or edit the switching points of the cams, to adjust the Delay Time compensation or to shift all cams of an output or an output track stepwise.

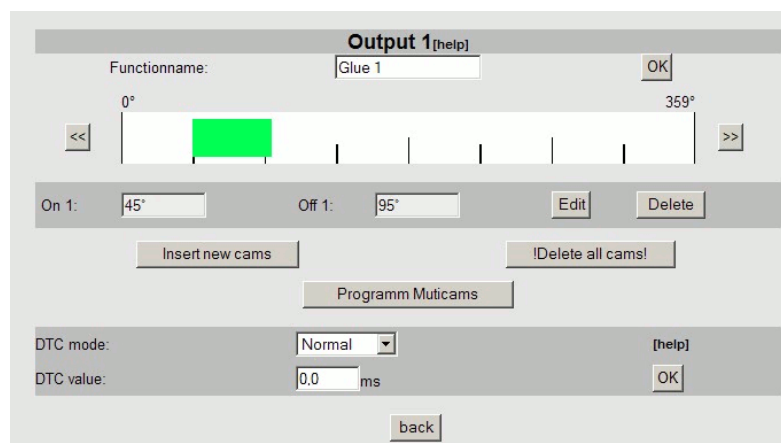

In addition, the option "**Programm Muticams**" can be used to fill up a cam track with multiple cams automatically.

Hint: If you let the cursor „hover“ above the green box of a cam, the switching points will be displayed in a small pop up box.

6.5.2. Entering the Speed Compensation

You can select between five different modes of Delay Time compensation according to the configuration in the menu "**System setting**" -> "**System upgrading**".

Note: You will find information about the function and calculation of the speed compensation in chapter "2.1. Speed Compensation".

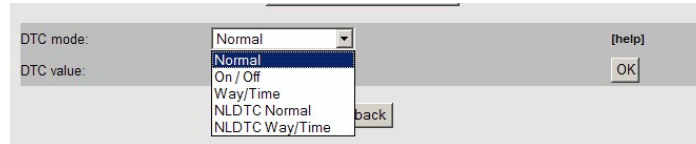

"Normal" The selected Delay Time affects in- and outputs similarly.

"In/Out" Different times can be selected for in- and outputs.

Attention: If the off-switching point overtakes the switching on at increasing velocity in this mode, a non-defined signal occurs !

"Way/Time" A way/time cam has a defined length at each velocity. It enables e.g. to control the dispersion of glue so that a defined amount is dispersed at any velocity. The switching is defined by position triggered values and the selected speed compensation.

Note: The cam itself has also a selected switching point for on- and off switching. The on switching is used as a positive trigger edge, the out switching as a negative. If several cams are programmed and the next trigger edge reaches an off-switched cam at increasing velocity, both cams will be combined to a single cam.

6.5.3. Selecting the Non - Linear - Speed Compensation

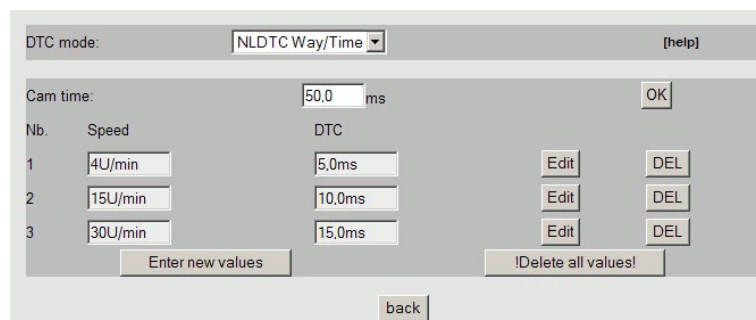

"NLDTC Normal" The non-linear speed compensation makes it possible to trigger or compensation switching procedures that show a non-linear behavior, like break or accelerating ramps. For this purpose, a chart with Delay Time and velocity values is created within the unit to create a speed compensation characteristic. The selected speed compensation affects the on and off switching equally.

On the right you can see a characteristic with five interpolation points from 20 ms to 30 rev/Min. In the range of 30 to 50 rev/Min, the speed compensation interpolates a raise to about 40 ms. The maximum speed compensation is reached at 90 rev/Min with 60 ms.

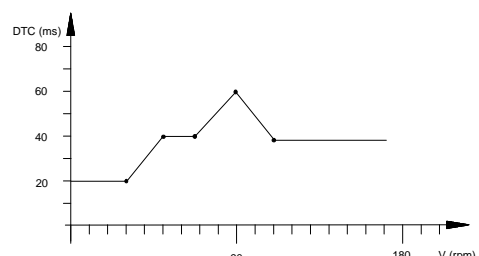

"NLDTC Way/Time" This mode requires – just as it is with the normal speed compensation – also the switching time of the cams.

6.6. System settings

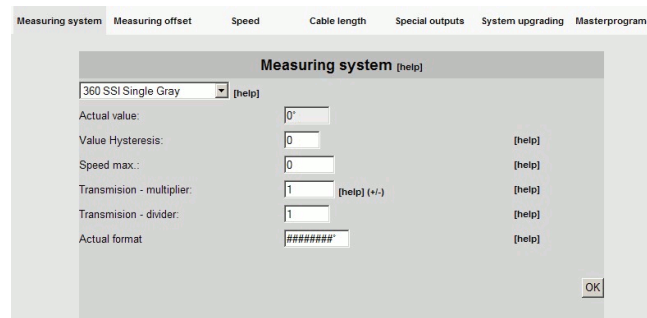

Select the system parameter of your cam switch of your CamCon controller here.

6.6.1. Measuring system

Parameter the measuring system of the cam switch here.

6.6.1.1. Select measuring system

You can choose between different preset measuring systems. The most common are SSI single turn angle encoders with 256, 360, 512, 1000, 1024, 2048, 4096 or 8192 steps or multiturn angle encoders with different transmissions and triggers, but also two analog SSI converter modules AWA can be selected.

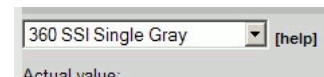

Note: Should you not be able to select values at the upper resolution range, the cause might be that there is not enough RAM memory available.

If the measuring system option is not available in the menu, you have to select a "**Special measuring system**". See also chapter "6.6.1.6. Configuration of the special measuring system" on page 34 on this issue.

6.6.1.2. Value Hysteresis

This value is needed to suppress a „shimmy“ of the outputs at fluttering actual values. The exact value has to be determined by trials, it should nevertheless be always as small as possible or 0. The hysteresis can be between 0 and ¼ of the total resolution (maximum), it has nevertheless a 125 pulses maximum.

6.6.1.3. Speed max or measuring system control

The menu option "**Speed max.**" can be used to set the maximum acceptable actual value skip per cycle, a feature that can be used to control the Measuring System. The needed value can be calculated from the CamCon's recent cycle time, the physical resolution or the machine's speed.

Note: The resolution must be entered as a physical property. If, for example, a Measuring System with 4096 pulses is employed and a transmission gear (3600/4096) reduced the displayed value to 3600 pulses, a resolution of 4096 has to be used in the calculation!

Example: Cycle Time = 0.5ms / Resolution = 360 / Machine Velocity = 180 min⁻¹.

$$\text{Speed - Max} = \frac{\text{Resolution} * \text{Machine Velocity}}{(60 * 1000)} * \text{Cycle Time} + \text{Security Stock}$$

$$360 * 180 / (60 * 1000) * 0.5 + 5 = 5.54 \approx 6$$

The rounded result is entered in the "**Speed max.**" box.

If the CamCon now detects a skip of more than six pulses for the actual value, an error message "**Ist-Err:5**" or "**Error Number 5**" is displayed.

If a zero is entered here, the measuring system control is switched off. The maximum value is 9999 pulses.

6.6.1.4. Electronic Gear Transmission

The option "**Transmission - multiplier**" and "**Transmission - divider**" can be used to enter a transformation factor for the measuring range. This makes it possible to transform the physical measuring range of e.g. a rotating angle encoder into a visible measuring range for the user. The standard transmission is set to 1:1.

The measured actual value is then multiplied by the selected factor and then divided by the divisor. The thereby calculated value is the displayed value.

Example: A machine moves 1000mm for a full rotation (360 steps) of an angle encoder. If the value should not be displayed in 360 steps of one degree each it is necessary to set the transmission to $1000 / 360$. Keep in mind that the display will nevertheless not progress in steps of one mm, as the resolution (360) remains unaffected. If you would type in $100 / 360$, the actual value is calculated down to a range of 100. The position is then displayed in cm, although a floating decimal is still not possible.

Note: A negative "**Transmission - multiplier**" value changes the counter direction or the rotation of the Measuring System respectively.

6.6.1.4.1. The Electronic Rotation Direction Switch

The counter direction of the Measuring System can be selected with the "**Transmission - multiplier**" (see previous chapter) by changing the algebraic sign.

Note: After a change of the counter rotation direction, the zero value (offset) has to be adjusted anew.

6.6.1.5. Actual Value Display Format

Use this option to select the display format for the actual value or the cam programming.

The hash marks are wild cards for the display value. The remaining digits can be used to enter additional input like the measuring unit (e.g. mm, cm or inch) for linear systems.

If you want to use a decimal point, you could enter it between the hash marks (like this: ###.##mm)

6.6.1.6. Configuration of the special measuring system

If your Measuring System is not available in the default options, you will have to configure a special measuring system for the CamCon.

There are nine different special measuring systems available at the moment.

- **Name:** When configuring a special measuring system, you can select a name and description of up to two lines length under "**Name:**".

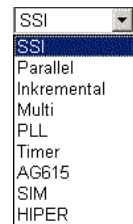

6.6.1.6.1. Special measuring system - SSI

The special measuring system SSI is needed if you are running a SSI measuring system with special parameters (e.g. a SSI encoder with 500 steps).

- **Resolution in bits** Number of used data bits of the SSI measuring system.
At a resolution of e.g., 500 pulses, that makes 9 bits.

- **Offset in bits** Position of the lowest bit (LSB).
For our example, that would be the position of the LSB's at the ninth position.
Further information can be found in the manual of your Measuring System.

Note: This value has to be at least equal to the "**Resolution in bits**".

- **Capping** Enter the capping of the Gray – Code here.
For our example that would be: $(512 - 500) / 2 = 6$.

- **SSI-Error bit** Enter the position of the SSI Errorbit here. For standard rotating angle encoders manufactured by Stegmann the Bit position 14 is needed. This position in the SSI protocol has always to contain a zero.

Note: If no zero can be detected here (e.g., because the wire broke down), the CamCon delivers the error message "**Pos-Err:2**" or "**Error Number 2**" respectively.

6.6.1.6.2. Special measuring system - Parallel

- **Resolution** Enter the resolution of the parallel Measuring System here (e.g. 500 pulses).

- **Start input** Enter the input number of the lowest value bit (LSB) here. In our example that would e.g. be the position of the LSB at input #7. At a resolution of 500 pulses, a nine bit resolution is needed. The CamCon determines the inputs automatically from the position of the LSB in ascending order. In our example input 7 to 16 would be attributed to the bits of the parallel angel encoder in accordance.

- **Mode** The "**Mode**" option can be used to program the parallel Measuring System. It can be set to **Gray** = Graycode or **Bin.** = Binary code.

Attention: A parallel binary code should only be used as an exception. Contact the customer service for this issue.

6.6.1.6.3. Special measuring system - Incremental

- **Resolution** Enter the maximum number of pulses here. This value is used as the maximum resolution for the calculation of the cams. If the unit registers more pulses than this set maximum, it restarts counting again at zero.
The option "**Measuring offset**" can be used to switch the movement "**System**" to "**linear**", a counter overflow triggers a "Clear..." or "Error 3" message at the CamCon. You will have to increase the resolution or to set the actual value to zero using a preset or clear signal.
- **Divisor** The divisor multiplies or divides measured pulses from the Measuring System with a set factor. The following scalers can be used: "***4**", "***2**", "***1**", "**/2**", "**/4**", "**/8**", "**/16**", "**/32**", "**/64**", "**/128**", "**/256**", "**/512**".
If, for example, the divisor is set to "***4**", an encoder or Measuring System with a resolution of 500 pulse could transmit up to 2000 pulses to the unit (four times the resolution).
- **Clearemode** Is used to set the additional inputs C1 and C2. You can choose between eight optional settings:
 - "**C1 & C2**" If input C1 is high and C2 high too, the counter is set to zero.
 - "**/C1 & C2**" If input C1 is low and C2 is high, the counter is set to zero.
 - "**C1 & /C2**" If input C1 is high and C2 is low, the counter is set to zero.
 - "**/C1 & /C2**" If input C1 is low and C2 low too, the counter is set to zero.
 - "**C1 : W**" If input C1 is high, the counter is set to zero.
If input C2 is high, no further pulses are counted (Wait).
 - "**/C1 : W**" If input C1 is low, the counter is set to zero.
If input C2 is high, no further pulses are counted (Wait).
 - "**C1 or ↑C2**" The counter is set to zero if C1 is high or C2 switches from low to high.
 - "**C1 or ↓C2**". The counter is set to zero if C1 high or C2 switches from high to low.

6.6.1.6.4. Special measuring system - Multi

This Measuring System is needed to use a multiturn turn-encoder (4096*4096 with 24Bit) with a non-binary number of revolutions.

If e.g. the encoder at the shaft revolves more than one turn, but your machine just operates in a single step or product.

- **Resolution** Total resolution of the Measuring System at the CamCon used to calculate the cams.
- **Turns** Multiplier for the factor of revolutions at the encoder's shaft.
- **Turn - divisor** Divisor for the factor of revolutions at the encoder's shaft.

Example 1: Using a rotary disc with a 3 to 1 transmission gear, at which the encoder turns three times per one revolution of the disc. These three revolutions correspond to 360 pulses (360 degrees).

The following presets are required:

"Resolution" = 360 / **"Turns"** = 3 / **"Turn - divisor"** = 1.

Example 2: Using a rotary disc with a 12.5 to 1 gear transmission gear. The encoder turns 12.5 times with each revolution of the disc shaft. These 12.5 rotations would now correspond to 3600 pulses (360.0 degrees).

The following presets are required:

"Resolution" = 3600 / **"Turns"** = 25 / **"Turn - divisor"** = 2.

Attention: This Measuring System works only in combination with a multiturn angle encoder with a resolution of 4096 x 4096 pulses (Type: AAG66107 or AAG626).

Note: Never turn the encoder more than 512 times without power supply, otherwise the preset zero is lost.

6.6.1.6.5. Special Measuring System - PLL

The PLL Measuring system (Phase - Lock - Loop) determines the position by interpolation of a single pulse over time (like a photo cell or limit switch).

If e.g. a rotating disk is equipped with an initiator and you want to measure the recent position at a certain, constant speed without having to install a second Measuring System the PLL is a good solution.

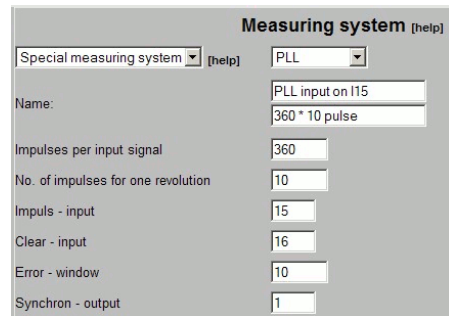

- **Impulses per signal** Enter the number of steps between each pulse.

- **No. of imp.f. one rev.** If one rotation triggers several pulses you can enter their number here.

Note: The number of pulses that the CamCon uses to calculate the cams is the result of a multiplication of this two menu points (e.g. $360 \cdot 10 = 3600$ pulses).

- **Impuls - input** Set the input number for the initiator pulse

- **Clear - input** Input number for the clear – signal used to set the zero value

- **Error - window** If a step error or a departure bigger than the preset value in the error window is detected, the unit switches into the asynchronous mode and switches the "**Synchron - output**" off.

- **Synchron - output** Cam output number for a synchronous state of operations. This output is active as long as the PLL Measuring System is running in the synchronous mode or within the "**Error - window**" respectively.

6.6.1.6.6. Special measuring system - Timer

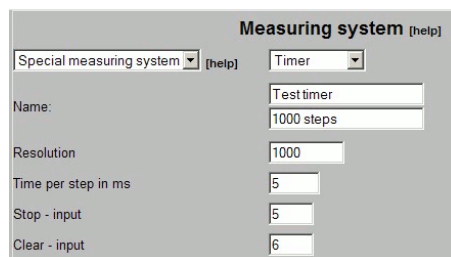

The timer ways simulator helps to create actual time values or ways without a hardware system, on time basis. The cam switch works similar to the control program of e.g. a washing machine or a time relay control.

- **Resolution** Enter the number of steps that the CamCon shall use to calculate the cams (Total Time).

- **Time per step in ms** Time delay between the single steps in milli seconds (ms).

- **Stop - input** Used to release the timer system. A high signal at this input sets the timer off, a low signal stops it. If you do not want or need a stop input, just enter „0“ in here.

- **Clear - input** A high signal at this input resets the timer to „0“ or halts it at „0“. If you do not want or need a clear input, just enter „0“ here.

Example: If the option "**Time per step in ms**" is set to 5 and a "**Resolution**" of 1000 is defined, the total running time will be 5 seconds ($5\text{ms} \times 1000 \text{ steps} = 5 \text{ seconds}$).

6.6.1.6.7. Special measuring system - AG615

Special measuring system	[help]	AG615
Name:	AAG615-8192	
	to 5 * 360 step	
Resolution	360	
Turns	5	

The AG615 - Single - Multiturn – Measuring System creates a multiturn Measuring System from an AAG615 - 8192 Singleturn - Unit.

- **Resolution** Set the resolution that the CamCon shall display per turn (e.g. 360).
- **Turns** Set the number of uses or revolutions that the CamCon shall create (e.g. 5).

The results are several revolutions or uses of the CamCon with each turn of the AAG615.

Example: At a value of 5 * 360 the CamCon counts from 0 up to 359 five times if the AAG615 - 8192 encoder rotates once at the shaft.

6.6.1.6.8. Special measuring system - SIM

Special measuring system	[help]	SIM
Name:	Test Simulator	
	5000 sec.	
Resolution	5000	
Increment per sec.	1000	
Stop - input	7	
Clear - input	0	

The SIM – Measuring system (Simulator) helps to create actual values from time basis without the need for an additional measuring system. Compared to the timer Measuring system, a higher speed is possible.

- **Resolution** Enter the number of steps that the CamCon shall use to calculate the cams (e.g. 5000).
- **Increment per sec.** Enter the speed or the pulses per second here (e.g. 1000).
- **Stop - input** Used to release the timer system. A high signal at this input sets the SIM timer off, a low signal stops it. If you do not want nor need a stop input, just enter „0“ here.
- **Clear - input** A high signal at this input resets the SIM timer to „0“ or halts it at „0“. If you do not want nor need a clear input, just enter „0“ here.

Example: At a resolution of 5000 and a speed of 1000 pulses/second a velocity of 5000 is simulated.

6.6.1.6.9. Special measuring system - HIPER

This Special measuring system is used if the CamCon is equipped with an incremental Measuring System input and an uneven gear transmission is likely to cause an error overflow (roll over function).

- **Multiplier** Enter the multiplier for the gear transmission.

- **Divisor** Enter the divisor for the gear transmission (e.g. 5 / 7).

Note: Each edge change is counted = quadrupling.

- **Resolution** Enter the maximum needed number of pulses here. This value is the maximum resolution used for the calculation of the cams. If the unit registers more pulses than this set maximum, it restarts counting again at zero.

The option "**Measuring offset**" can be used to switch the movement "**System**" to "**linear**", a counter overflow triggers a "Clear...." or "Error 3" message at the CamCon. You will have to increase the resolution or to set the actual value to zero using a preset or clear signal.

- **Clearemode:** Is used to set the additional inputs C1 and C2. You can choose between eight optional settings:

"C1 & C2" If input C1 is high and C2 high too, the counter is set to zero.

"/C1 & C2" If input C1 is low and C2 is high, the counter is set to zero.

"C1 & /C2" If input C1 is high and C2 is low, the counter is set to zero.

"/C1 & /C2" If input C1 is low and C2 low too, the counter is set to zero.

"C1 : W" If input C1 is high, the counter is set to zero.

"/C1 : W" If input C2 is high, no further pulses are counted (Wait).

"/C1 : W" If input C1 is low, the counter is set to zero.

"/C1 : W" If input C2 is high, no further pulses are counted (Wait).

"C1 or ↑C2" The counter is set to zero if C1 is high or C2 switches from low to high.

"C1 or ↓C2". The counter is set to zero if C1 high or C2 switches from high to low.

6.6.2. Measuring offset

Movement - "**System**" = Rotatory (standard)

Measuring offset <small>(help)</small>	
Actual value:	<input type="text" value="39°"/>
System:	<input type="text" value="rotatory"/>
Offset:	<input type="text" value="0°"/>
Preset value:	<input type="text" value="0°"/>
Preset input no.:	<input type="text" value="0"/>
Preset value store typ:	<input type="text" value="RAM"/>

Movement - "**System**" = linear

Measuring offset <small>(help)</small>	
Actual value:	<input type="text" value="124°"/>
System:	<input type="text" value="linear"/>
Start position:	<input type="text" value="-10°"/>
End position:	<input type="text" value="349°"/>
Offset:	<input type="text" value="10°"/>
Preset value:	<input type="text" value="0°"/>
Preset input no.:	<input type="text" value="1"/>
Preset value store typ:	<input type="text" value="EEPROM"/>

- **System:** Can be used to select the controlled system: Either rotatory (like packaging machines, trimmers or eccentric presses) or a linear system like a positioning unit or a toggle press.
- **Offset:** The offset is subtracted from the physical actual value, thus giving you the possibility to shift the zero value.

 Note: If the "**System**" is set to linear and the direction of rotation is set to negative, the "**Offset**" value has to be below zero (e.g. -359). See also chapter "6.6.1.4.1. The Electronic Rotation Direction Switch".
- **Start position:** Here you can set a start value if your "**System**" is set to linear. From this value on the cam values will start.

 Hint: You can also use negative values.
- **End position:** This value changes automatically if the "**System**" is set to linear and the "**Start position**" or the resolution is changed. This value is always the highest possible programmable cam value and cannot be changed.

 Attention: If the start or end value is overrun, the CamCon switches of, displaying an error message "Pos-Err 3" or "Error: 3".
- **Preset value:** This value can be used in both the „rotatory“ as well as in the „linear“ condition to set a physical value to a new, preset value by adding an input (positive edge).
 You could e.g. set the preset value to zero to create an external zero signal which can be used to synchronise a machine.
- **Preset input no.:** Enter the number of the input that sets the preset value as an actual value once it's triggered by a positive edge.
- **Pr. value store typ:** This option is used to determine whether a saved preset is tolerant against power failures.
 Using the "**RAM**" – memory loses the preset every time the device is switched off and on again.
"EEPROM" – saving copies the preset from the RAM into the EEPROM memory to make it robust against power shortages.

 Attention: *The EEPROM memory should only be used if the preset is rarely triggered and absolutely necessary, since the number of writing turns into the EEPROM memory is limited (to about 100000 cycles). After that, the EEPROM is ultimately damaged and the CamCon's programming data is lost.*
- Note: The Preset Input will be read in in real time from software date 21.5.2002 on. Therefore it can be synchronised with a machine.

6.6.3. Speed

This menu is used to set the CamCon's speed display according to the turning speed of your machine. You can e.g. alter the displayed speed by several factors or adjust a dampening to prevent a fluttering of the display.

- Speed factor: Usually the measured speed is displayed in pulses/second. If you want to use another unit like e.g. revolutions/min, a calculating factor has to be set here.

Example 1: A rotating angle encoder with 512 steps delivers 512 increments per minute, indicating a speed of one turn per minute. The CamCon measures $512/60 = 8.533$ pulses/second. To set the display to revolutions/minute, a factor of $1/8.533$ has to be used.

Example 2: A rotating angle encoder with 360 steps delivers 360 increments per minute, indicating a speed of one turn per minute. The CamCon measures $360/60 = 6$ pulses/second. To set the display to revolutions/minute, a factor of $1/6 = 0,16666$ is required.

Note: This factor is affected by the electronic gear transmission. See also chapter "6.6.1.4. Electronic Gear Transmission".

- Speed display format: Set the display format for the speed display here. The hash characters are wildcards for the display value. If e.g. the value is smaller than 1000, only three characters are needed – enter three hash characters. If you need a decimal, simply add it between the hashes (e.g. `###.# rev/min`).

- 100% Speed value: This menu point is used to set the maximum speed value of your plant. It is used to adjust the speed display: if e.g. an analog speed output is used, this value indicates the point where the analog value reaches its maximum.

Note: The endpoint of the bar chart for a CamCon DC50/51 or CD/CT10 terminal display is also affected by this value, as is the 5% trigger threshold of the position to the speed display (if the "Display" menu is set to "Automatic").

- Accuracy of speed display: A smaller value dampens the display speed making it less affected by fluttering values (thus increasing the accuracy).

This dampening uses a deep pass to level the display, resulting in a more "average" display value. The smaller the set value, the more stable the display will be. It is therefore practical to decide for a compromise between dynamic and readability.

Hinweis: Both these values affect the speed value that a PLC Backplane, like an S7 or ControlLogix or a C16/ P delivers to an attached PLC.

- Display:** This is only necessary when using a CamCon DC50/51 or CD/CT10 terminal display. You can choose between three modes:
- "automatic"** If a 5% (of the set 100% turning speed) input threshold is passed, the position display switches to a speed display, with the bar chart representing the speed in percent.
 - "speed"** The bar chart only display the speed (not the position) in percent of a set 100% maximum speed.
 - "position"** The display only indicates the position. The bar now displays the position between start (0%) and end 100%): e.g. 0% = 0 degree / 50% = 180 degree / 99% = 359 degree).
- Switching input:** If you set the **"Display"** option to "speed" or "position", you can use the input number of the CamCon that switches the display of the CamCon DC50/51 or CD/CT10 terminal display.
- If the input is not active, the set display mode ("speed" or "position") is always displayed. The switching from one to another can be triggered by an input signal

6.6.4. Cable length

Cable length/cycle (help)	
Cable length:	<input type="text" value="0m"/>
max. DTC:	<input type="text" value="1310.7ms"/>
Cycletime:	<input type="text" value="0.000ms"/>
Actual cycle time:	<input type="text" value="0.080ms"/>

- Cable length:** Here you can enter the length of the cable that connects the SSI Measuring System with the CamCon.
- This is necessary, since the length of the wiring directly influences the speed of data transmissions: The longer the cable is, the slower the transmission and the bigger the cycle time will be.
- Note:** If you use the „external Interface“ for an I/O- expansion and the cable of the SSI Measuring System is shorter than the one between the I/O-modules (e.g. DC91 or AWA) and the CamCon, you have to enter the length of the longest cable (in meters).
- ! Attention !** *Cables with more than 300 meter length require a specially configured SSI Measuring System as well as I/O-expansion modules with changed mono-flop-times.*
- max. DTC:** Displays the maximum possible Speed Time compensation value of the unit.
- Cycletime:** As a standard CamCon works with the shortest possible cycle time if you set this value to zero.
- The cycle time can, nevertheless, be shortened or increased, which is necessary to e.g. you use a Measuring System that can only read the SSI data once in a specific time (e.g. an ultrasonic sensor) or the CamCon's RAM memory would otherwise not be sufficient.
- Actual cycle time:** Used to display the current cycle time of the CamCon.
- Note:** Using the Digisoft 2000 program "Offline", this value is always"55.555ms".

6.6.5. Special outputs

Special outputs digital [help]

Safty output/RUN-Control:

Send position:

Direction output:

Move detection output:

Direction hysteresis:

Hysteresis of move detection output: in percent of the "Direction hysteresis"

Special outputs analog

Speed analog:

Analog cam:

The special outputs are divided into analog and digital signals:

6.6.5.1. Special outputs digital

- Safty output/RUN-Control:

To have the possibility to control the CamCon even in cases of short circuits in the control channels or errors of the Measuring System, a rotating cam can be programmed for a single cam output. This output is only switched of if an error occurs and can therefore be used as a safety output.

If the programming changes, the safety output will be reset. See also chapter "6.6.6. System upgrading" on page 47.

A "0" in the input box means that no safety output has been programmed.

- Send position

The CamCon provides the opportunity to put the actual value directly and in real time onto the outputs.

This option is used for devices like the DC300 or the 1756-DICAM as well as for the Profibus configuration CP16/P to have the actual value in real time available for a PLC.

You can choose between four different settings:

- "no" = Actual value is not put out.
- "Gray" = Actual value is put out as a gray code on the outputs (physical value).
- "Binary" = Actual value is put out in binary code for a DC300, 1756-DICAM and CP16/P. (displayed value includes factor, offset and direction of turn).
- "Exp." = Actual value is put out as a gray code only with CamCon DC115 for a Master - Slave - Connection.

With this function, the lowest value bit is counted first the others follow later (actual value of 32 bits) behind the last defined output.

Example 1: For a CamCon with e.g. 32 hardware outputs, this is output 33. If the actual value shall be available at the 24V-outputs, the number of defined hardware outputs has to be reduced to e.g. 16, to have the first 16 Bit of the actual value on outputs 17-24.

Example 2: For a CamCon DC300 or 1756-DICAM with 24b hardware outputs and 16 virtual inputs via the back plane this is e.g. the virtual backplane output 41.

- Direction output:

You can set a cam output that displays the direction of the machine's movement or rotation.

For a positive movement or rotation, the cam output is switched on, for a negative it is switched off.

Note: If the direction of movement changes, the output can only be switched if the threshold set in "**Direction hysteresis**" is exceeded.

- Move detection output:** Use to set an output for the indication of movement.
The output is switched if the threshold set in "**Direction hysteresis**" is exceeded in positive or negative direction.
- Direction hysteresis:** Set the threshold speed for the "**Direction output**" – and the "**Move detection output**" here.
To be able to use the "**Direction output**" – and/or the "**Direction output**" correctly, you have to set a threshold value at which the movement is indicated or the cam output switches.
- Hysteresis of move d. output:** Used to dampen a fluttering of the Move detection output for small velocity changes.
You can use values between 0 and 99% of the "Direction hysteresis".
- Example: If the "Direction hysteresis" threshold is set to e.g. 10rev/min and this value is set to 50%, the output switches on at a number of revolutions of 15 rev/min, and off again on 5 rev/min.
- Note: Only available for CamCon firmware version 3/2006 or higher.

6.6.5.2. Special outputs analog

- Speed analog:** With this function activated (set to "Yes"), the CamCon displays the measured speed at the outputs.
It is therefore possible to provide speed data in real time for a CamCon DC300, 1756 DICAM or Profibus CP16/P.
The speed is displayed as a 16 bit value behind the last defined output and shifts if the option "**Send position**" is set, between the 32Bit actual value and the last defined output.
- Example: 32 "normal" outputs + speed (16Bit) + actual value (32Bit) = 80 Bits.
Also in this case not available hardware outputs are set as virtual outputs to the back plane of the PLC.
- Note: Since the measured actual value is in most cases smaller than 16 Bit, the higher bits can be ignored.
The 16 Bit speed value is already formatted by the "**100% Speed value**" to be usable for a CamCon DAC16 digital analog converter. Once the measured speed reaches the set value of 100%, a DAC16 with voltage output gives +10V or 20mA for a power output. At 0% velocity, e.g. 0V or 10mA and for -100% = -10V or 0mA could be displayed.
- Note for S7, CLX and CP16: If the value is transmitted digitally via the back plane or a CP16/P/IO into the PLC, the DAC16 formatting has to be removed or calculated out. At 0% speed a value of 32768 and for 100% speed 65535 is displayed. Therefore, you have to first subtract 32768 and then scale up to 100%.
- Note: The CamCon DC51 can be purchased with integrated analog outputs. For this option, the analog value can be displayed at the first analog output (clamp 2).

- Analog Cam: The CamCon can display cams not only as digital 24Volt outputs but also create position sensitive „analog cams“. Select the number of analog cams that the CamCon shall use (from 0 = none to a maximum of 14).

In most cases, this directly corresponds to the number of analog hardware outputs.

Note: If the option "**Speed analog**" is set to "**Yes**", the first analog output is used to indicate the speed.

6.6.5.2.1. Analog cam configuring

- Nb.: Choose the cam you want to configure or program.

- Format: Select the desired input format. The hash characters are wildcards for the actual numerical value.

It is possible to use percent ("####.##%" (Standard)), voltage "###.###V", pressure in bar "#.###mbar", in Ampere "##.###mA" or in any individual unit.

- Minimum: Used to set the minimum input value (e.g. -100.00% or -10.00V).

This value is the threshold from which on the minimum value of the analog output is displayed and used as a reference for the input.

- Maximum: Used to set the maximum input value (e.g. 100.00% or 10.00V).

This value is the threshold from which on the maximum value of the analog output is displayed and used as a reference for the input.

Note: The CamCon always uses 16 Bit values for its analog cams that are compatible to the CamCon DAC16 - D/A - converter.

This means that the smallest binary value ("0") at the DAC16 corresponds to the smallest analog value of -10Volt or 0 respectively 4mA. The biggest binary value of 65535 corresponds to the biggest analog value of +10V or 20mA.

Example 1: If the minimum is set to -100.00% and the maximum set to +100.00%, a programmed analog value of -50% triggers a voltage output of -5V or a power output of 5mA.

Example 2: A minimum of 0 and a maximum value of 50, result in a programmed analog value of 25 with an output voltage of 0V or 10mA current respectively.

- **Disable input:** The output of the analog cam value can be frozen by setting an input to a specific value.

For this purpose enter the number of the input that shall be used to set the corresponding analog value to the "**Disable value**".

- **Disable value:** Enter the value that shall be displayed if the "**Disable input**" is active.

This value must not be above the maximum or below the minimum value!

Note: If no cam is programmed for the used analog output, the "**Disable value**" is used as a default value.

- **Interpolation:** If this option is set to "On", the CamCon interpolates the programmed values from interpolation point to interpolation point to form a smooth curve.

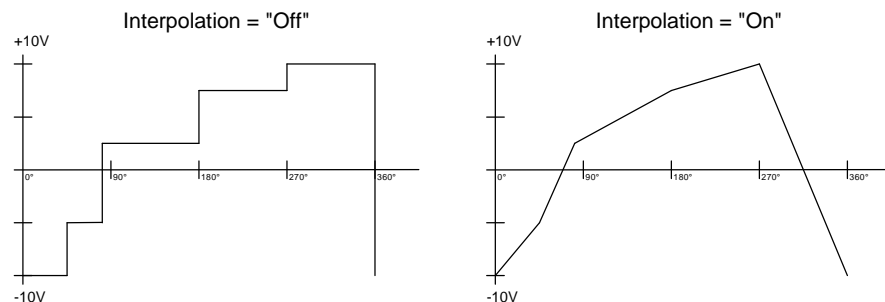

- **Factor:** Enter a multiplier factor in percent. If you use e.g. a value of 200%, an input of 10 mA would be displayed as 20mA. An input of 20mA for a 200% factor would nevertheless cause an overflow.

- **Offset:** Use this option to set an Offset.

An offset of e.g. 5mA has an input of 10mA displayed as 15mA.

6.6.5.2.2. Programming analog cams

The lower section of the analog cam input is used to program the actual analog cams:

Nb	Position	Analog value		
1	<input type="text" value="0°"/>	<input type="text" value="0.00%"/>	<input type="button" value="Edit"/>	<input type="button" value="DEL"/>
2	<input type="text" value="180°"/>	<input type="text" value="99.00%"/>	<input type="button" value="Edit"/>	<input type="button" value="DEL"/>
<input type="button" value="Enter new values"/>			<input type="button" value="Delete all values!"/>	

Therefore, each interpolation point (e.g. 180°) is attributed to an analog value (e.g. 9.99V).

The interpolation points can be deleted (DEL), all deleted (Edit) or attributed to new values.

They are displayed in a rising order.

6.6.6. System upgrading

The screenshot shows the 'System upgrading' menu with the following settings:

- physical inputs: 16
- physical outputs: 16
- DTC outputs: 16
- NLDTTC (not linear SC): 8 used: 1
- Key - lock - input: 0
- Error quit input: 0
- Enable - input: 0
- Strob input of external prg. selection: 1
- No. of prg. for external selection: 16
- Typ of programm selection: by actual value
- Actual value: 0

- **physical inputs:** Display the number of available physical inputs that are configured in the "Configure hardware" Menu.

- **physical outputs:** Display the number of available outputs that are configured in the "Configure hardware" Menu.

Note: If the "PLC - Logic - Module" is switched on, this menu is used to set the software in- and outputs (P. and N.) for the cam switch module.

The screenshot shows the 'System upgrading' menu with the following settings:

- Inputs: 16
- Outputs: 16

- **Inputs:** Used to define the number of inputs (P) for the cam switch.

- **Outputs:** Used to define the number of outputs or cam tracks (P) for the cam switch.

- **DTC Outputs:** Used to define the number of cam tracks that use Delay Time compensation.

This value should not be more than the number of absolutely necessary outputs to save cycle time and memory space.

- **NLDTTC (not linear SC):** Enter here the number of available "Non – Linear – Speed compensation Values" that you want to have must be set. The maximum number is 246.

Try to keep this value as small as possible to save valuable memory space!

The "used:" window displays the number of configured NLDTTC.

- **Key - lock - input:** When using a CamCon DC50/51 terminal display, you can select an input number at which a Signal (+24V DC) triggers a keyboard lock.

If the selected input is set to "0" the keyboard lock is inactive

- **Error quit input:** A positive edge (+24V DC) at the selected input acknowledges an error message at displayed at the CamCon ("Pos - Error": 1,2,3 and 5).

Note: An "Output - Error" or "Error: 4" can nevertheless not be acknowledged.

- Enable - input:** A Signal (+24V DC) at the selected input enables the cam outputs. A 0V DC signal locks them, respectively.
- If this input is set to "0", the enable function is switched of and the cam outputs are always available.
- Note:** With the PLC - Logic - Module switched on, not the outputs („O“) but the cam outs („N“) are locked or enabled.
- Attention:** A CamCon with a direct PLC connection via a CP16 or CP340 or a CamCon DC300 and a 1756-DICAM should always have the enable function set to zero (switched of), as the PLC already provides a similar function.
- Strob input of ...:** The CamCon provides the possibility to use 24V inputs to switch between programs and program numbers.
- For this purpose select an input number for the switch or takeover pulse.
- A 24 Volt pulse at this input selects the chosen program number. The pulse must be at least 20ms behind the program number and have a length of 100ms or more.
- If this input is set to "0" the external program selection is switched off.
- Nmb. of prg.:** Select the number of programs that can be switched with the 24V inputs.
- This number depends on the number of available inputs: The program number is set as a binary number after the switch pulse at the inputs, with the lowest bit at the input being the switching pulse. This allows for a shifting of the program selection inputs.
- Example 1:** For 8 available inputs a maximum of 128 programs (0 to 127) can be selected, if the switching pulse is configured for input 1.
- Example 2:** For 8 available inputs a maximum of 8 programs (0..7)) can be selected, if the switching pulse is configured for input 5, since e.g. inputs 1 to 4 are used for other functions.
- Typ of .. selection:** A change of the program can be done on three different ways:
- "slow"** The selected program builds up cam by cam.
- This program change does not require additional RAM memory space, but can cause problems if a program switch occurs while the machinery is operating at full capacity.
- The CamCon's safety or RUN - control output is switched off for a short time for this option.
- "direct"** The RAM memory is used to build up the program cam by cam. The switch itself occurs swiftly.
- This option requires the double RAM memory's space but does not leave a cam output undefined.
- The CamCon's safety or RUN - control output is not switched off for a short time for this option.

"by actual value" This option uses the RAM memory to build up the program cam by cam. The unit then waits until a certain actual value is reached to trigger a program change.

Also this option requires the double RAM memory's space but does not leave any output undefined.

The CamCon's safety or RUN - control output is not switched off for a short time for this option.

- Actual value: This box is used to define the actual value for the switching point if the program selection mode is set to **"by actual value"**.

6.6.7. Masterprogram

Masterprogramm

Mastermodul: ▾

Programm No.:

Master programm outputs:

Outputs 1 - 8:

Outputs 9 - 16:

The CamCon can be used to define global (transprogram and transproduct) machine/plant cams.

This can be necessary if your machine is used to process different products that have only little differences in the cam programming and helps to save memory space in the EEPROM, as the cams are product depended and do not have to be programmed multiple times.

- Mastermodul: If you want to use the master program option, switch it to **"ON"**.

- Programm No.: Enter a program number at which the master cam shall be saved.

You can use any number between 0 and 32767, but we recommend using either 0 or 32767.

- Output 1 - n: Select cam outputs that shall be used as master cams.

Example: If the master program cam is set to 32767 and uses output 1, a cam that uses program 32767 and output 1 is used even if the automatic program is switched to 0. The cam programmed for program 0 is ignored.

Note: Programing the master cam is done in a similar fashion to the „normal“ cams. See also **"Cam programing"**.

If you do not use the master program, this is selected automatically for the input (any recent program is switched off).

Here you can change the desired master cam.

6.7. Configuration menu

You can order the CamCon cam controller with different hardware configuration, interfaces and options.

This menu is used to define the hardware configuration and to set the device parameters of the CamCon.

6.7.1. Configure hardware

- physical inputs: Enter the number of physical cams of the CamCon and any possible I/O expansion set at the „external interface“.

The number of inputs always has to be equal to the number of available inputs as the unit detects overloads and short circuits via the inputs.

Example 1: For a CamCon DC16 with a DC16/IO expansion module, this number has to be set to 24.

Example 2: For a CamCon DC190 with a DC16/IO expansion module at the "external interface" this value has to equal to 32.

- physical outputs: Enter the used number of physical outputs here.

Note f. S7 and CLX: The number of outputs should not surpass the number of electric outputs as a maximum. It can, nevertheless be raised to up to 64 (CamCon DC300) or 200 (1756-DICAM). These outputs are then only transferred virtually via the back plane of the PLC without the need for additional hardware (e.g. a DC16I/O).

Example 1: For a CamCon DC16 with a DC16/IO expansion module this value has to be set to 32.

Example 2: For a CamCon DC190 with a DC16/IO expansion module module at the "external interface module this value has to be set to 48.

Note: If you want to use a speed or actual value display at the outputs, the output number decreases by the corresponding number of bits.

16Bit for a speed display and another 16 (if necessary 32Bit) for the display of the measured value.

See also chapter "6.6.5.1. Special outputs digital" on page 43 and "6.6.5.2. Special outputs analog" on page 44.

- **CP-Typ:** If a CP16 Profibus Module (Order No.: CP16/P/IO) is attached at the unit's "external interface", set this parameter to "**CP16/P/IO**".

The menu will change then so that you can set the following parameter:

- **Slave adress:** Set also the desired Profibus DP address here.

- **CP inputs:** In addition to the CamCom's physical inputs the CP16 can simulate inputs that are controlled by a PLC (e.g. PLC outputs).

Enter the number of desired simulated CamCon inputs here. The sum of physical and simulated inputs may only be 248.

Attention: These simulated inputs must not be directly read out at the cam switch or the PLC - Logic - Module as they are not defined in the communication setup between the CP16 and the CamCon.

This inputs (I) must be connected to the speciality outputs of the S005 Bit of the PLC - Logic - Module with an AND – connection, since they are set to 1 for a successful communication.

- **CP outputs:** Just as with the inputs, an additional number of hardware outputs can be simulated. These are the read out by the PLC as inputs.

Enter the number of desired simulated CamCon outputs here. The sum of physical and CP outputs may only be 200 (maximum).

More on the function and configuration of the C16 can be found in the device's manual.

6.7.1.1. Advanced hardware configure

To have the CamCon meet the rising requirements for flexibility, an advanced hardware configuration was introduced.

This option can be used to adapt a complex PLC Logic Module Program to several different CamCon hardware option. If a program was originally written for a DC16 with 8 in - and 16 outputs, the same program must be adapted for the use with a CamCon DC190 with 16 in - and 32 outputs.

With this function it is possible to change the position of in- and outputs or the allocation of backplane data at a CamCon DC300 or 1756-DICAM to expand the programming flexibly and without the need for totally new programming in the S7 or CLX.

The advanced hardware configuration is currently available for three interfaces of the unit:

- for the "external interface" or the CamCon hardware in – and outputs if a CamCon with "X" Option (external interface) and I/O expansion like e.g. a DC16 IO, DC91/92 IO, DA - or AD – Converter is used.
- for virtual in- and outputs via a back plane bus of the CamCon Plugin series of a DC300 and 1756 - DICAM.
- for a FAST - Ethernet I/O or Ethercat – interface of a DC190.

6.7.1.1.1. Advanced hardware configuration for CamCon and external interface

Number Device ID	Inputs	Outputs
1	Inp 1- 8: I001 - 008 Inp 9- 16: I009 - 016	Out 1- 8: O 001 - 008 Out 9- 16: O 009 - 016 Out 17- 24: O 017 - 024 Out 25- 32: O 025 - 032
2	Inp 1- 8: I017 - 024 Inp 9- 16: I025 - 032	Out 1- 8: O 033 - 040 Out 9- 16: O 041 - 048
3	EMPTY	

Buttons: OK, EtherCat hardware configure

For the advanced - hardware – configuration of an external interface a software module called I/O-Router is used.

It is a modular system beginning with a module 1. (first) and a number of n further modules.

To activate the I/O router select a Cam Con basic unit for the first module (e.g. a DC190) to be used.

To switch it off (and delete all (!) entries) it is sufficient to set the basic device to "**EMPTY**" in the first module and press the OK button.

Depending on the type CamCon or module you can now address inputs and outputs, e.g. the hardware outputs of a module to the corresponding in- and outputs of a CamCon.

Note: To activate virtual outputs (which do not have a hardware structure), devices like a CamCon DC300 and 1756-DICAM use the "**Standard/O**" module.

6.7.1.1.2. Back - Plan - Router Configuration

This option is only available if you selected a DC300 or 1756-DICAM as the basic module of the I/O router.

6.7.1.1.3. Ethercat hardware configuration

This option is only available if you have selected the basic module DC190 in the first module of the I/O router.

Nr	EtherCat device	IN	OUT
Nr 1	EK1100 EtherCat bus interface		
Nr 2	EL2004 4 Out		1 -4
Nr 3	EL2004 4 Out		5 -8
Nr 4	EL2004 4 Out		9 -12
Nr 5	EL1014 4 In	1 -4	
Nr 6	EL1014 4 In	5 -8	
Nr 7	EL4112 2x Analog Out 0-20mA		Nocke 17 Nocke 18
Nr 8	EL9010 Bus end modul		

OK

EtherCat table synchronization

It is used to select and configure the FAST - Ethernet I/O or Ethercat – interface of the CamCon DC190.

The FAST Ethernet I/O interface is, just as the I/O router, a modular system, beginning with the first module, the FAST Ethernet I/O basic module (like e.g. a Beckhoff EK1100) and n other modules (e.g. ET2004 = quadruple output module or ET1014 = quadruple input module as well as a Bus – terminal - module (e.g. Beckhoff EL9010).

Depending on the selected basic module you can now define the configuration of the module line and the connection or the routing of in- and outputs.

Note: Inputs that are defined here that are connected to the I/O router will be OR connected.

The outputs can be selected more than once – it is e.g. possible to define the output 1 for the second and fourth module.

Online: If you are connected with the CamCon DC190 and a FAST Ethernet I/O System is attached, the module configuration can be created automatically by clicking the "**EtherCat table synchronization**".

6.7.2. PLC configuration

The PLC - logic - module of the CamCon combines the hardware - in - and outputs to the internal Cam controller software. This connection is virtual in - and outputs of the PLC - Logic - Module realized. By this technique it is possible, all activities of the cam controller of PLC logic module to change, and to control.

In this menu, the PLC - logic - module is switched "on", "off" or to configure.

PLC configuration		
PLC-Modul:	On	[help]
usable hardware inputs:	32	[help]
usable hardware outputs:	48	[help]
M - registers:	32	[help]
X - registers:	0	[help]
Timer / Counter:	8 used: 0	[help]
Virtual inputs, S7 PAB or ControlLogix local.O:	64	[help]
Special inputs:	96	[help]
Shift:	8 used: 0	[help]
Max. length of an Shiftregister:	1014	[help]

6.7.3. Key allocation

Entries in this menu are only necessary for the classical CamCon devices with the CamCon Programming interface can be operated or when an external terminal via RS232 or RS485 connected (eg DC51 or DC51 DC190 with Terminal / T [2/4]).

Key allocation		
Insert user key		
Name:	User	[Edit]
Name:	Master	[Edit]

In this menu, the access permissions of the user key are defined.

Users are identified only by entering the key. The name is just for the Key Management and is not used in the CamCon system. The respective rights and permissions by clicking on the button "Edit" or open the next menu.

Name:	User
Password:	Pass
Allow program selection:	<input checked="" type="checkbox"/>
Allow cam programming:	<input checked="" type="checkbox"/>
Allow system menu:	<input type="checkbox"/>
Allow unit configuration:	<input type="checkbox"/>
Allow PLC programming:	<input type="checkbox"/>
Allow user menu:	<input checked="" type="checkbox"/>
Allow cam programming for very output:	No
Outputs 1 - 8:	<input checked="" type="checkbox"/> <input checked="" type="checkbox"/> <input checked="" type="checkbox"/> <input checked="" type="checkbox"/> <input type="checkbox"/> <input type="checkbox"/> <input type="checkbox"/> <input type="checkbox"/>
Outputs 9 - 16:	<input type="checkbox"/> <input type="checkbox"/> <input type="checkbox"/> <input type="checkbox"/> <input type="checkbox"/> <input type="checkbox"/> <input type="checkbox"/> <input type="checkbox"/>

6.7.4. Unit Configuration

In this menu, the device can be completely deleted, and the serial port, and various special parameters can be adjusted.

Configure unit

Format unit: [help]

Protocol of the serial interface: [help]

Device Number: [help]

EEprom : [help]

Language: [help]

7. PLC - Logic - Module programming

The PLC - Logic - Module of the CamCon will programmed in this menu.

PLC - editor

CamCon PLC - logic - modul

Selected network: < 1 > OK Free inputs in this network: 7

N 1

Standard

Name	Label	Symbol comment:	Symol editor
O001	-	-	Cross reference
N001	-	-	Cross reference

8. Error messages and removal of errors (FAQ)

The error messages appear on the standard display or in CamCon DC16, 90, 115, 190, 300 and 1756-DICAM without a display of their own through the status LED or status bits.

The drawings below shows the error message appearing.

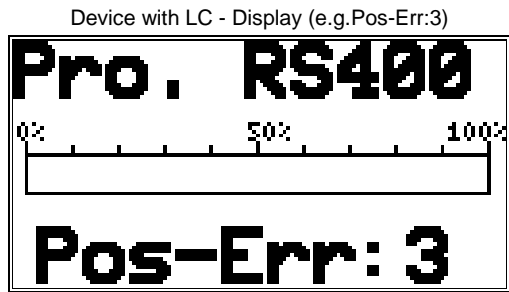

Device via Digisoft 2000 or WEB (e.g.Pos-Err: 2)

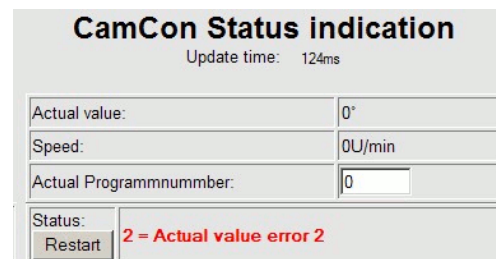

9.1 Problem: Display shows "No contact to unit: XX".

Possible causes:

The wiring is probably not correct, no device with the selected unit number is on the BUS or the setting of the 'Ser.Mode' is wrong.

Solution:

Check the wiring and the configuration of the serial interface.

See chapter "4.2.1. PIN - Allocation of the Serial Interface RS232" on page 16 and chapter "6.7.4. Unit Configuration" on page 55.

8.2. Problem: "Pos - Err:1" respectively error number 1.

Possible causes:

The measuring system has not been correctly connected.

Solution:

Please check the wiring to the measuring system. Please consult the instruction manual to the measuring system.

If the error is eliminated, the error-message can be deleted by pressing

8.3. Problem: "Pos - Err:2" respectively error number 2.

Possible causes:

The measuring system is faulty or not connected.

The setting of the error bits in the special measuring system setting is not correct.

Solution:

Check the wiring to the measuring system.

Check the inputs of the measuring system resolution.

Consult the instruction manual of your measuring system.

If the error is eliminated, the error-message can be deleted by pressing

8.4. Problem: "Pos - Err:3" respectively error number 3.

Possible causes:

The resolution of the connected measuring system is not in accord with the input resolution. The measuring system is faulty. The actual value is outside the range which was entered in the menu path setting for linear systems. See Chapter "6.6.2. Measuring offset" on page 40. If an incremental measuring system is set, then this report is an alternative for the message "**Clear...**".

Solution:

Check the input of the measuring system setting, the offset value and the cable length setting. Consult the instruction manual of your measuring system. Consult Chapter "**Problem: Clear...**".

If the error is eliminated, the error-message can be deleted by pressing

8.5. Problem: "Pos - Err:5" respectively error number 5.

Possible causes:

The measuring system control is activated. The CamCon has registered a large unacceptable actual value jump. The measuring system is possibly faulty.

Solution:

Check the input of the measuring system setting and of the setting of the cable length or increase the permitted actual value jump. Consult Chapter "6.6.1.3. Speed max or measuring system control" on page 32. Consult the instruction manual of your measuring system.

If the error is eliminated, the error-message can be deleted by pressing

8.6. Problem: An "Pos-Error:" occurs during operation.

The monitor displays "Pos-Err:1", "Pos-Err:2", "Pos-Err:3" or "Pos-Err:5".

Possible causes:

The connection cable of the measuring system or the measuring system itself is defective. A cable without screening or without dual strand was used. The laying of a connection cable in the vicinity of a strong electromagnetic source of interference (e.g. high voltage cable, motor cable) can lead to an pos error.

Solution:

Check the wiring to the measuring system. Replace the measuring system. Take measures for screening. Lay the connection lead in another location. Consult the instruction manual of your measuring system.

If the error is eliminated, the error-message can be deleted by pressing

8.7. Problem: "RAM-Full" = RAM memory is full.

Possible causes:

The resolution of the measuring system is too large.
The number of outputs is too high.
The number of Speed Compensated outputs is too high.

Solution:

Check the input of the measuring system setting.
Reduce the measuring system resolution.
Reduce the number of Speed Compensated outputs.

Please contact your customer service representative if you require a RAM memory extension.

8.8. Problem: The EEPROM memory is full.

Cause:

Too little memory space available in the EEPROM for the storage process.

Solution:

Please contact your customer service representative if you require an EEPROM storage extension. Also consult Chapter "9. Technical Data on page 60.

8.9. Problem: Outputs will not activate

Possible causes:

An error message is active. The outputs are not connected to power supply. A programmed Cam is too short or gets too short by increasing rotation speed. The enable - Input is not set.

Solution:

Check the error message. Program a longer Cam. A Cam with delay-time/speed-compensation must at least have the length of two steps.

Enable Outputs at the enable-Input, see also chapter 6.6.6. System upgrading on page 47

Enable the outputs through the S5 PLC. Consult your handbook for the S5-L1 linkage.

8.10. Problem: "Out - Error" respectively error number 4.

Possible causes:

Your outputs are overloaded or short-circuited. Check the wiring and the connection output as well as possible inductive loads which have no zero setting or are driven by a cancellation component.

The number of set inputs is not correct.

Power failure at an external interface module (e.g. DC91/IO or DC16/IO).

Solution:

See chapter "4.7. Outputs" on page 24.

See chapter "6.6.6. System upgrading" on page 47.

See chapter "6.7.1. Configure hardware" on page 50.

If the error is eliminated, the error-message can be deleted by pressing 
Here the attempt to reset outputs is done

Warning:

Wires crossing behind the outputs, if the cables leading towards the switch-OFF of the outputs are in an awkward position, can lead to a switch-OFF of the outputs, since in an open situation a potential is built up which, when the contacts are closed, is led back into the outputs.



In inductive loads the outputs must be organised with a flywheeling diode. Protection or induction in the switch cabinet in the immediate vicinity of the device or due to their wiring have an effect on the device or its wiring and must be organised with cancellation components.

8.11. Problem: Error in the EEPROM respectively error number 255.



Possible causes:

The data of the EEPROM was changed or destroyed by interference.

One of the existing data carriers (EEPROM or EPROM) was renewed or is defective.

The power supply was switched OFF during alteration of the data.

Solution:

Press  for yes and then the  key. All data will be erased and must be re-entered. Should these errors occur repeatedly, please contact your customer service.

8.12. Problem: "Error ???"

Possible causes:

An unpredictable error has occurred.

Solution:

Please contact your customer service.

8.13. Problem: "Clear...." respectively error number 3

Cause:

The CamCon is waiting for the arrival of the Clear signal in an incremental measuring system.

Solution:

Set the Clear signal ON or activate an actual value Preset. The result is the immediate release of the Cam Switch Unit.

Note: The incremental measuring system is only available as an option for CamCon DC16, DC50/51, DC115, DC190, DC300 and CamCon 1756-DICAM.

See chapter "6.6.1.6.3. Special measuring system - Incremental" on page 35.

9. Technical Data

Display	a status LED for the in- and outputs (48) each, 5 status LEDs for the power supply, 3 LEDs for the operation mode, 2 Ethernet and 2 EtherCAT Status LEDs
Interfaces	Ethernet, EtherCAT, Digitronic external Interface, RS232 or RS485 and SSI or 24V HTL
Number of outputs	32, expendable to 248 outputs when using an external interface or EtherCAT
Number of inputs.....	16, expendable to 248 inputs when using an external interface or EtherCAT
Number of cam tracks.....	200
Number of programmable cams	around 65000 cam
Memory	Flash and F-RAM
Number of programmes.....	32768
Cycle time, (switching speed)	from 80µs, configured as needed (optimized)
Speed compensation (DTC)	individual for each output, corresponding to the Measuring System and memory available
Configuration range of DTC	-9999.9 to 9999.9ms, corresponding to the Measuring System and memory available
Measuring System - Inputs	2 x synchronous serial (SSI) gray encoded, optional one or two incremental inputs (HTL), parallel input or other kinds of input
Measuring System Resolution	360 steps (Standard), otherwise configured according to the Measuring System and memory available
Measuring System (SSI)	AAG60007, AAG612-2048, AAG612-4096, AAG612-8192, AAG626 or AAG66107
SSI – Tact rate (abhängig von der Kabellänge) ..	0 - 9m = 781kHz / 10 - 56m = 390kHz 57 - 149m = 195kHz / 150 - 1000m = 98kHz
Measuring System (incremental)	ADG60/24/500 or any other 24V 90° pulse signals
Border Frequency of the incremental Input.....	approx. 100kHz
Level of the incremental Input.....	24V PNP (HTL only)
Zero point correction for the Measuring System ..	programmed in the CamCon
Rotation direction of the Measuring System	programmed in the CamCon
Length of cable between Measuring Systems and CamCon.....	for SSI up to max. 300m (optional up to 1000m)
Power supply.....	24V DC ±20 %
Measuring System – supply voltage	with 24V DC via supply voltage of the unit
Power consumption	200mA without Measuring System or outputs and load
Output voltage.....	24V DC, plus switching (PNP)
Output current	0,5A per output, 100%ED, short circuit proof
Programing	via Ethernet with WEB Browser, Digitronic DIGISOFT 2000 Programm, CamCon DC50/51 Terminal or CamCon CT10 Terminal.
Connections for:	
Measuring System	screw clamps IP20
Power supply.....	screw clamps IP20
Cam outputs.....	screw clamps IP20
Mounting	simple Snap-On mounting on symmetrical carrier rail (EN 50 022), can be mounted in a row
Dismounting	durch Zurückziehen des Schnappriegels
Dimensions	(see chapter "3.1. Dimension" on page 13)
Protection.....	corresponds to IP20
Working Temperature.....	0°C ... + 55° C
Weight.....	ca. 820g

10. Index

Actual value.....	40
Actual Value Display Format.....	33
Analog cams, configuring.....	45
Analog measuring system input.....	22
Analog, cam programming.....	46
Analog, speed.....	44
Back - Plan - Router.....	52
brake functions.....	11
Cable covering.....	13
Cable length.....	42
Cam programming.....	30
CamCon, option.....	29
CE.....	2
centre pressure.....	11
Clear mode.....	35
Clear.....	59
Commissioning.....	26
Configuration, Ethercat.....	53
Connections, electrical.....	14
CP inputs.....	51
CP outputs.....	51
CP16 Module.....	51
Cycle time.....	42
Cycle time, default.....	42
Delay time compensation, Effects.....	8
delay time for Speed Compensation, separate for switch-ON and switch-OFF points.....	12
Delay time, Calculation.....	10
Dimensions.....	13
DIP - Switch.....	18
Direction output.....	43
Direction Switch.....	33
Direction, hysteresis.....	44
DP Address.....	51
EEProm storage is full.....	58
EEPROM, Error.....	58
Enable, input.....	48
Entering cams.....	30
Error acknowledge, input.....	47
Error messages.....	56
Ethercat.....	53
External interface.....	18
External interface, advanced configure.....	52
Grounding connections.....	13
Hardware Advanced configuration.....	51
Hardware, configuration.....	50
HIPER - Special measuring system.....	39
Hiperface.....	22
Hysteresis, Actual Value.....	32
I/O - Router.....	52
Incremental.....	39
Incremental measuring system input.....	21

Input wiring.....	24
Inputs, general	24
Inputs, Hardware, configure.....	50
Installation	13
IP - Address	26
Key allocation.....	54
Keyboard - lock - input.....	47
Linear	40
Main menu	29
Master cams	49
Master program.....	49
Measuring offset	40
Measuring system.....	32
Measuring System Control.....	32
Measuring system incremental	35
Measuring system, General information	20
Move detection output.....	44
Move detection, Hysteresis	44
Moving, detection	44
NLDTC	47
NLT	12; 31
No contact to unit XX	56
Offset	40
Out - Error.....	58
Outputs, additional	51
Outputs, general.....	24
Outputs, Hardware, configure.....	50
Outputs, lock.....	48
Parallel measuring system input.....	20
Password	27
PDF - File.....	2
Pin allocation.....	14
Pin allocation, 1. SSI measuring system.....	14
Pin allocation, 2. incremental measuring system.....	14
Pin allocation, 2. SSI measuring system.....	14
Pin allocation, EtherCat interface.....	19
Pin allocation, Ethernet interface	19
Pin allocation, external interface	18
Pin allocation, incremental measuring system.....	14
Pin allocation, Inputs 1-16.....	15
Pin allocation, Output 1-16.....	15
Pin allocation, Output 17-32.....	16
Pin allocation, power supply.....	14
Pin allocation, Serial Interface.....	16
Pin allocation, Serial Interface RS232.....	16
Pin allocation, Serial Interface RS485.....	17
Plant cams	49
Plant program	49
PLC - modul - configuration	54
PLC - Module - programming.....	55
PLL measuring system input.....	23
Pos - Err 1	56
Pos - Err 2	56
Pos - Err 3	57

Pos - Err 5.....	57
Preset.....	40
Profibus.....	51
programm selection, external.....	48
programm selection, mode.....	48
Project data.....	29
Proxy.....	27
RAM-Full.....	57
RoHS.....	2
Roll - Over.....	39
Rotatory.....	40
Router, I/O.....	52
RS232 as a measuring system.....	23
RUN-Control.....	43
Safty output.....	43
Select measuring system.....	32
Send actual value.....	43
SIM, Special measuring system, Simulator.....	38
Simulation.....	30
Special measuring system.....	34
Special measuring system - AG615.....	38
Special measuring system - Multi with gear.....	36
Special measuring system - PLL.....	37
Special measuring system - SSI.....	34
Special measuring system Timer.....	37
Special outputs.....	43
Special outputs, analog.....	44
Special outputs, digital.....	43
Speed.....	41
Speed analog.....	44
Speed Compensation, Effects.....	8
Speed compensation, entering.....	31
Speed compensation, nmb. of outputs.....	47
Speed compensation, non linear.....	31
Speed Compensation, not linear.....	12
Speed compensation, not linear.....	47
Speed display format.....	41
Speed display, accuracy.....	41
Speed factor.....	41
Speed-Max.....	32
SSI measuring system input.....	20
Status Display.....	25
Statusdisplay.....	29
System settings.....	32
System upgrading.....	47
Table of contents.....	3
Technical Data.....	60
Term.....	18
Terminal Resistors, Serial Interface RS485.....	18
The status LED.....	26
Time -Cam.....	12
Timer.....	37
Timer as a measuring system.....	23
total deletion.....	28
Transmission, electronic gear.....	33

Unit Configuration	55
Update.....	2
User.....	27
V-Max.....	32
Welding operations, Safety precautions	24
Zero point move	40
Zero point move, extern	40